

Processing a Calibration Inspection



Release 4.6B



Copyright

© Copyright 2000 SAP AG. All rights reserved.

No part of this brochure may be reproduced or transmitted in any form or for any purpose without the express permission of SAP AG. The information contained herein may be changed without prior notice.

Some software products marketed by SAP AG and its distributors contain proprietary software components of other software vendors.

Microsoft®, WINDOWS®, NT®, EXCEL®, Word® and SQL Server® are registered trademarks of Microsoft Corporation.

IBM®, DB2®, OS/2®, DB2/6000®, Parallel Sysplex®, MVS/ESA®, RS/6000®, AIX®, S/390®, AS/400®, OS/390®, and OS/400® are registered trademarks of IBM Corporation.

ORACLE® is a registered trademark of ORACLE Corporation, California, USA.

INFORMIX®-OnLine for SAP and Informix® Dynamic Server™ are registered trademarks of Informix Software Incorporated.

UNIX®, X/Open®, OSF/1®, and Motif® are registered trademarks of The Open Group.

HTML, DHTML, XML, XHTML are trademarks or registered trademarks of W3C®, World Wide Web Consortium, Laboratory for Computer Science NE43-358, Massachusetts Institute of Technology, 545 Technology Square, Cambridge, MA 02139.

JAVA® is a registered trademark of Sun Microsystems, Inc., 901 San Antonio Road, Palo Alto, CA 94303 USA.

JAVASCRIPT® is a registered trademark of Sun Microsystems, Inc., used under license for technology invented and implemented by Netscape.

SAP, SAP Logo, mySAP.com, mySAP.com Marketplace, mySAP.com Workplace, mySAP.com Business Scenarios, mySAP.com Application Hosting, WebFlow, R/2, R/3, RIVA, ABAP, SAP Business Workflow, SAP EarlyWatch, SAP ArchiveLink, BAPI, SAPPHIRE, Management Cockpit, SEM, are trademarks or registered trademarks of SAP AG in Germany and in several other countries all over the world. All other products mentioned are trademarks or registered trademarks of their respective companies.

Icons

Icon	Meaning
	Caution
	Example
	Note
	Recommendation
	Syntax
	Tip

Contents

Processing a Calibration Inspection	5
Inspection Instruction	7
Inspection Point (Equipment).....	8
Notification Item.....	9
Automatic Creation of an Inspection Lot	10
Planning Requirements for Inspection Lot Creation	12
Results Recording for Test Equipment.....	14
Generating a Work List for Results Recording.....	16
Recording Inspection Results Using a Work List	17
Recording Items for a Maintenance Notification	20
Usage Decision for Inspection Lot	21
Making the Usage Decision Manually.....	25
Completing a Maintenance Order Technically.....	26

Processing a Calibration Inspection

Purpose

This scenario describes how to process your test or measurement equipment in a calibration inspection. The objective of a calibration inspection is to determine whether each piece of equipment specified in the maintenance order meets the predefined performance specifications. In this process, you:

- Inspect the equipment specified in a maintenance order
- Record inspection results for each piece of equipment
- Valuate each piece of equipment
- Make the usage decision for the inspection lot

Prerequisites

You have completed all planning steps for the calibration inspection.

Process Flow

1. The system creates an inspection lot automatically when a maintenance order is released.
For more information about the system activities that take place when the inspection lot is created, see [Automatic Creation of an Inspection Lot \[Page 10\]](#).
2. You inspect the characteristics for each piece of equipment according to the information contained in the inspection instruction.
3. You record inspection results for all required characteristics in each operation. When you record inspection results, you valuate and close each characteristic in the operation, and then valuate each piece of equipment for the operation.

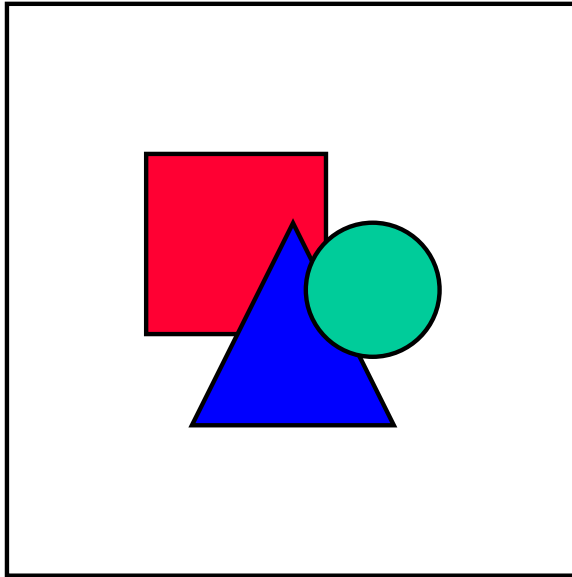
Processing a Calibration Inspection

When you record inspection results for a piece of equipment, you can also record [items for a maintenance notification \[Page 9\]](#) (for example, if you reject one or more inspection characteristics) and make confirmations to the maintenance order (for example, to record inspection times)

4. You make the usage decision for the inspection lot to complete the inspection and to trigger various [automatic follow-up actions \[Page 21\]](#).
5. You [complete the maintenance order \[Page 26\]](#).

See also:

[Results Recording for Test Equipment \[Page 14\]](#)

[Usage Decision for Inspection Lot \[Page 21\]](#)

Inspection Instruction

Definition

An instruction that describes the contents and procedures of an inspection to be carried out at a specific work center.

Use

The inspector uses the inspection instruction as a guideline for inspecting the goods in an inspection lot. The instruction can be printed out automatically by the system when an inspection lot is created or it can be printed out manually by the user.

Structure

The inspection instruction contains a summary of the data contained in the inspection lot and in the inspection specification (for example, the inspection plan). Typically, the inspection instruction contains the following type of information:

- Description of material/batch to be inspected
- Number of inspection lot
- Date of inspection
- Inspection operations subject to inspection
- Inspection characteristics to be inspected
- Inspection specifications for each characteristic:
 - Characteristic weight
 - Inspection requirement (for example, required or optional characteristic)
 - Recording form (for example, summarized value or original values)
 - Acceptance or rejection number
 - Valuation rule
 - Number of units to be inspected
 - Target value and tolerance ranges for quantitative characteristics
- Short and long texts for inspection method (if available)

Inspection Point (Equipment)

Inspection Point (Equipment)

Definition

A reference object for carrying out several inspections and recording characteristic results within an operation.

In a calibration inspection, each inspection point corresponds to an equipment number. In addition to the equipment number, the inspection point may also include several other optional fields that you can freely define.

Integration

When you plan a calibration inspection, you must maintain inspection point-related data in the following planning objects:

- Maintenance task list
 - At the header level of the maintenance task list, you specify the inspection point type (inspection points based on equipment).
 - In the QM data at the operation level, you specify how the inspection points are valued when you record inspection results. You can value each inspection point (equipment) manually or the system can value the inspection points automatically. The default setting is a manual valuation of the inspection points.
- Sampling procedures
 - For each sampling procedure used at the characteristic level of the maintenance task list, you specify an identifier for inspection points based on the inspection lot quantity (plant maintenance).

Notification Item

Definition

Specific information about a damage or defect item confirmed in a piece of equipment. A damage or defect item is:

- Any property or attribute of an equipment that does not meet the specification of an inspection characteristic
- Any abnormal property or attribute you confirm for which inspection characteristics were not planned

Automatic Creation of an Inspection Lot

Automatic Creation of an Inspection Lot

Use

When a maintenance order is released, the system automatically creates an inspection lot. In the process of creating an inspection lot, the system:

- Creates an inspection lot record in which it manages the inspection specifications and inspection results
- Copies the maintenance order number into the inspection lot record
- Generates inspection specifications for each piece of equipment ([inspection point \[Page 8\]](#)) and work center, (that is, it copies the inspection characteristics from the maintenance task list into the inspection lot)
- Determines the inspection lot quantity based on the number of pieces of equipment specified in the maintenance order
- Determines which inspection characteristics must be inspected more than once (repeat measurements) on the basis of the sampling procedures assigned to the characteristics in the maintenance task list
- Prints out the inspection instruction automatically, provided the automatic printout function was set in Customizing for *Quality Management*. If this function is not set, you can print out the inspection instruction manually, using the transactions for displaying or changing an inspection lot

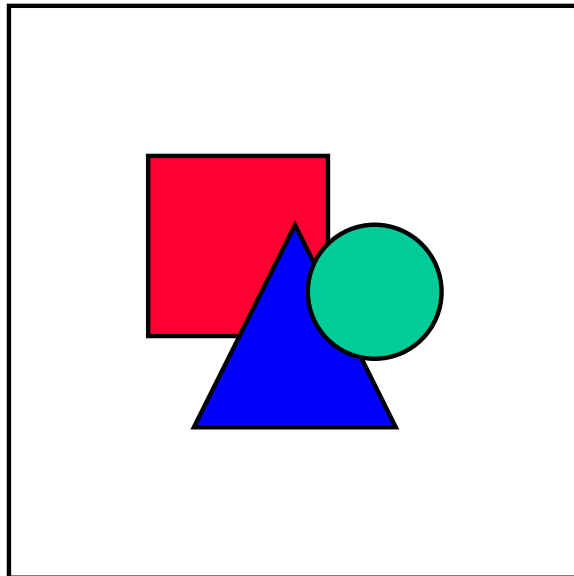

You cannot create an inspection lot manually. However, you can create and release a maintenance order manually, which causes the system to create an inspection lot automatically.

Prerequisites

You have completed all required [planning steps \[Ext.\]](#) for the calibration inspection.

See also:

[Planning Requirements for Inspection Lot Creation \[Page 12\]](#)

Planning Requirements for Inspection Lot Creation

Planning Requirements for Inspection Lot Creation

This example shows how the system responds when it creates an inspection lot, depending on which planning activities were completed.

The first table below provides an overview of several examples (cases) in which different combinations of planning steps were completed. The second table shows how the system responds in each case.

Planning Steps	Case 1	Case 2	Case 3	Case 4	Case 5	Case 6	Case 7
Was the inspection type assigned to the order type?	No	Yes	Yes	Yes	Yes	Yes	Yes
Was the maintenance task list assigned to an order?	-	No	Yes	Yes	Yes	Yes	Yes
Did you specify the field combination for inspection points in the maintenance task list?	-	-	No	Yes	Yes	Yes	Yes
Does the control key for the operation specify inspection characteristics?	-	-	-	No	No	Yes	Yes
Have inspection points been assigned to the operation?	-	-	-	No	Yes	No	Yes
	See item 1 below	See item 2 below	See item 3 below	See item 4 below	See item 5 below	See item 6 below	See item 7 below

Case / Item	System response
1	The inspection lot is not created.
2	The inspection lot is not created and the system records the status ILNC (inspection lot not created) in the maintenance order.
3	<p>The system creates the inspection lot and records the status ILCR (inspection lot created) in the maintenance order. In addition:</p> <ul style="list-style-type: none"> • The maintenance task list is assigned to the inspection lot. • Inspection characteristics are not created. <p style="text-align: center;"></p> <p>In this case, maintain the inspection point in the maintenance task list; then call up the function to change an inspection lot to create the inspection specifications.</p>

Planning Requirements for Inspection Lot Creation

4	<p>The system creates the inspection lot and records the status ILCR (inspection lot created) in the maintenance order. In addition:</p> <ul style="list-style-type: none"> • The system does not create inspection characteristics. • You can create unplanned inspection characteristics.
5	<p>The system creates the inspection lot and records the status ILCR (inspection lot created) in the maintenance order. In addition:</p> <ul style="list-style-type: none"> • The system creates inspection characteristics. • The system sets the status ICHA (planned inspection characteristics assigned) in the operation specified in the maintenance order. • The operation in the selection screen for results recording is highlighted and printed on inspection instruction. • You can create unplanned inspection characteristics.
6	<p>The system creates the inspection lot and records the status ILCR (inspection lot created) in the maintenance order. In addition:</p> <ul style="list-style-type: none"> • The system does not create inspection characteristics. • The operation in the selection screen for results recording is highlighted and printed on inspection instruction. • You can create unplanned inspection characteristics.
7	<p>The system creates the inspection lot and records the status ILCR (inspection lot created) in the maintenance order. In addition:</p> <ul style="list-style-type: none"> • The system creates inspection characteristics. • The system sets the status ICHA (planned inspection characteristics assigned) in the order operation. • The operation in the selection screen for results recording is highlighted and printed on inspection instruction. • You can create unplanned inspection characteristics.

Results Recording for Test Equipment

Use

After you inspect each piece of test equipment, you record inspection results for each characteristic in each operation to determine whether the recorded values are within the predefined inspection specifications. On the basis of the inspection results, you value and close each characteristic and then value each piece of equipment. The valuation specifies whether you accept or reject the equipment at the operation level.

You can record inspection results for the equipment in an inspection lot using one of the following functions:

- **Work list for results recording**

This is the recommended method for recording the inspection results for test equipment, especially if you want to process several inspection lots. Using this function, for example, you can generate a list of inspection lots for each work center. You can then drill down each inspection lot to display a hierarchical list of operations, equipment numbers, and characteristics.

For more information, see:

[Generating a Work List for Results Recording \[Page 16\]](#)

[Recording Inspection Results Using a Work List \[Page 17\]](#)

- **Record inspection results for equipment**

You can use this function if you want to record inspection results for a specific inspection lot. To use this function, you must know the number of the inspection lot for which you want to record results.

Integration

The valuation you make for a piece of equipment during results recording is a decision to accept or reject the equipment. When you make the usage decision for the inspection lot, the system makes a proposal on the basis of a follow-up action, so you can change the status of the equipment.

Prerequisites

You can only record inspection results for the equipment if the system:

- Created an inspection lot automatically on the basis of a maintenance order
- Generated inspection specifications for each piece of equipment

Activities

When you record inspection results for a piece of equipment, you:

- Enter an inspection result for each required characteristic
- Value and close each characteristic
- Value each piece of equipment at the operation level after all inspection characteristics have been valued and closed

Results Recording for Test Equipment

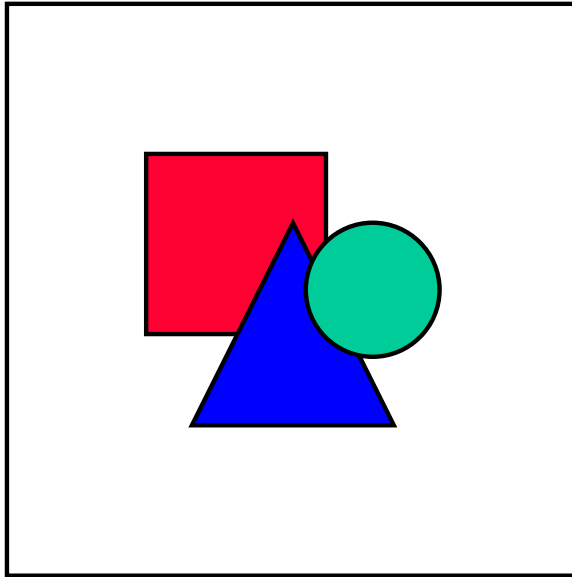

You can value the equipment manually or the system can value the equipment automatically in the background. You set the valuation mode for the inspection point in the maintenance task list (QM data at the operation level).

When you value the equipment, you can also make confirmations for the maintenance order (for example, inspection time).

- Record items for a maintenance notification, if you:
 - Reject an inspection characteristic for which the control indicator for defects recording was set
 - Confirm an abnormality for which an inspection characteristic was not planned

Generating a Work List for Results Recording

Generating a Work List for Results Recording

The graphic below shows how the system creates and displays a work list for results recording. The system generated the list in this example on the basis of a work center and the processing mode "1" (all characteristics).

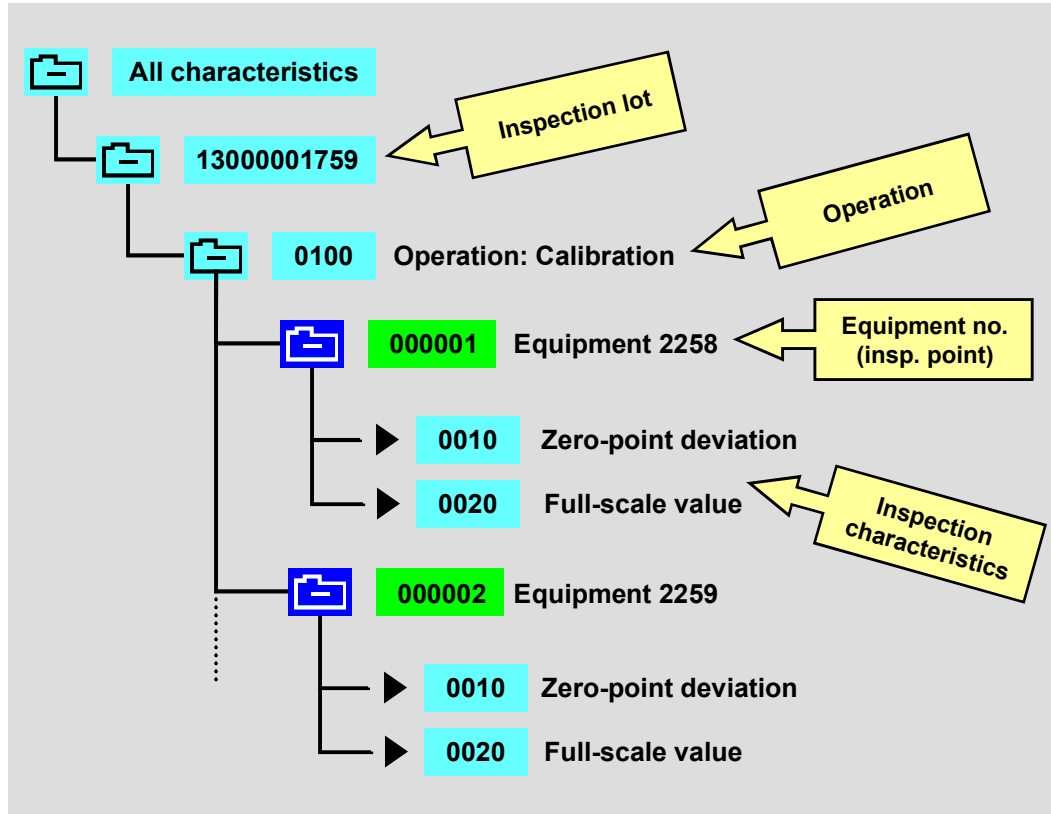

Recording Inspection Results Using a Work List

1. Choose *Logistics* → *Quality management* → *Test equipment management* → *Calibration inspection* → *Inspection results* → *Work list* → *Equipment (or Functional location)*.

A screen appears in which you can enter various selection criteria.

2. Enter the selection criteria in the corresponding fields (for example, inspection lot origin 14 and a work center).
3. Enter a value for the processing mode.
4. Choose *Execute*.

A list of the inspection lots that meet your selection criteria appears.

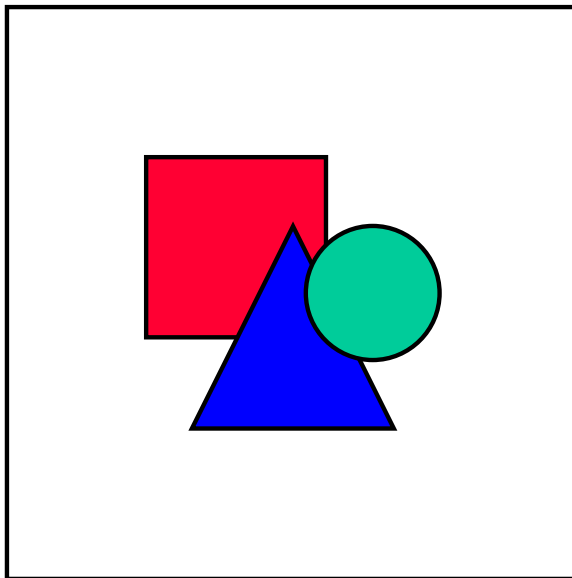

The list of inspection lots may be displayed in different colors. Choose *Extras* → *Legends* to display the color legend.

5. Double-click a folder and continue to drill down the structures until the system displays all equipment and the corresponding the inspection characteristics.
6. Double-click an equipment number.

The system displays the screen for recording the inspection results for the characteristics.

7. Enter an inspection result for each characteristic, then valuate and close each characteristic.

Recording Inspection Results Using a Work List

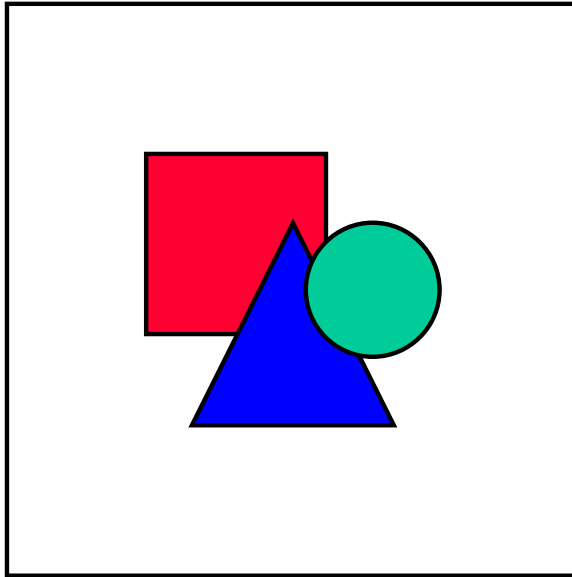

If you reject a characteristic for which the control indicator for defects recording is set, the system automatically displays a dialog box in which you can record one or more items for a maintenance notification.

8. Save the data.

If you must value the inspection points manually, a dialog box appears in which you can:

- Valuate a piece of equipment
- Make confirmations for the maintenance order

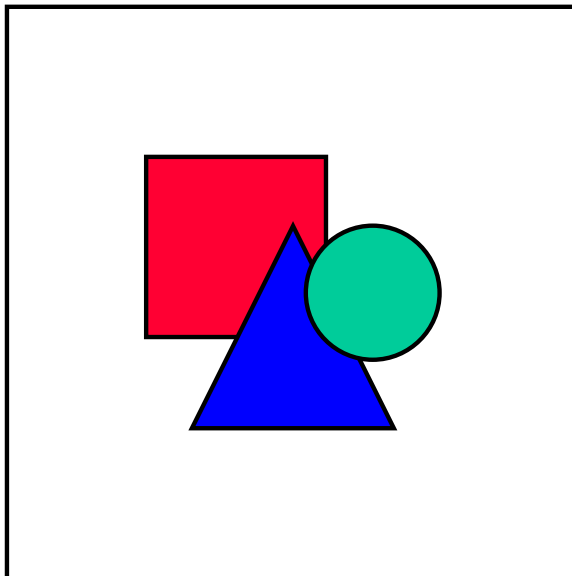

The system does not display this dialog box if the inspection points are to be valuated automatically by the system. The system valuates the inspection points automatically according to the settings in Customizing for *Quality Management*.

Recording Inspection Results Using a Work List

You can still, however, call up this dialog box manually using the corresponding menu function.

9. Accept or change the valuation and then choose *Continue*.

The system saves the valuation, exits the screen for results recording, and returns to the work list.

Recording Items for a Maintenance Notification

Recording Items for a Maintenance Notification

Use

If you reject an inspection characteristic for a piece of equipment during results recording or if you confirm an abnormality for which an inspection characteristic was not planned, you can record damage or defect items for a maintenance notification.

After you complete the inspection, you can process the maintenance notification further to analyze the cause of the item(s) and determine what corrective action is necessary. The maintenance notification in turn can trigger a repair order for the equipment.

Prerequisites

To record damage items for a piece of equipment during results recording, make sure that:

- The notification type assigned to the inspection type in Customizing for *Quality Management* is a maintenance notification
- You have set the indicator for defects recording in the control indicators for the inspection characteristic(s)

This causes the system to automatically display a dialog box for recording notification items when you reject a characteristic. If you do not set this indicator, you can call up a dialog box for recording notification items manually.

Usage Decision for Inspection Lot

Use

The usage decision for an inspection lot confirms that an inspection has been completed. The usage decision can also trigger automatic follow-up actions.

The usage decision can be made using one of several functions:

- You [make the usage decision manually \[Page 25\]](#) for a single inspection lot.
- You can make the usage decision manually for several inspection lots using the work list function.
- The system can make the usage decision automatically for one or more inspection lots by means of preplanned, periodically executed jobs.

Prerequisites

You can only make the usage decision for an inspection lot if:

- You have the user authorization to make the usage decision
- The inspection lot is released
- You have recorded inspection results for the inspection characteristics and all pieces of equipment have been valuated for each operation

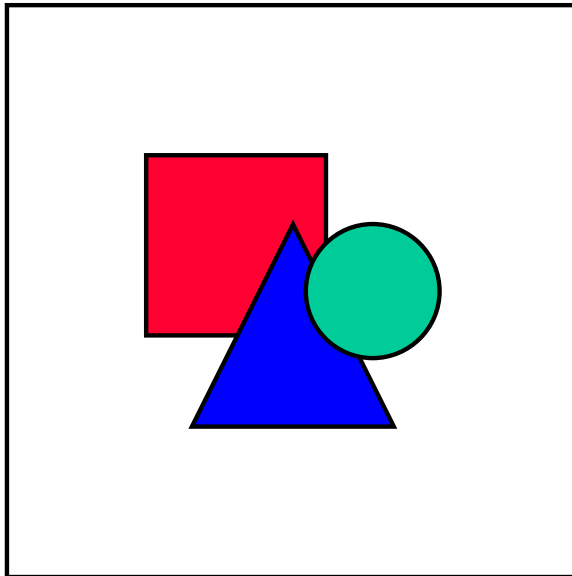

If you do not valuate each piece of equipment for each operation, you must confirm that the inspection was not completed when you make the usage decision.

- No active status exists for the lot which blocks the usage decision

Usage Decision for Inspection Lot

Features

When you make the usage decision for an inspection lot, the system can also execute the following functions automatically:

- Calculate the quality score
- Trigger automatic follow-up actions (provided they are linked to the usage decision code)

Automatic follow-up actions

When you save a usage decision code that is linked to one or more follow-up actions, the system automatically displays a dialog box with the following information:

- Preventive maintenance plan
- Current cycle modification factor
- Inspected pieces of equipment
- Current status of each piece of equipment
- Proposed status for each piece of equipment based on the valuation in results recording

In this dialog box, you can confirm or change the proposed equipment status and cycle modification factor.

When you save the usage decision code for an inspection lot, the system can trigger a follow-up action that executes the functions described below:

- **Updating the equipment status**

The system maintains a status for each piece of equipment in the equipment master record. This status specifies whether or not the equipment is released for use. When you process a piece of equipment in a calibration inspection, the inspection results may indicate that the equipment no longer meets the predefined performance specifications. When you record inspection results, you value the equipment with a rejection in one or more operations.

When you save the usage decision code for the inspection lot, the system displays the current equipment status (before you inspected the unit) and the proposed status (after you inspected the unit). You can change the current status according to the proposal.

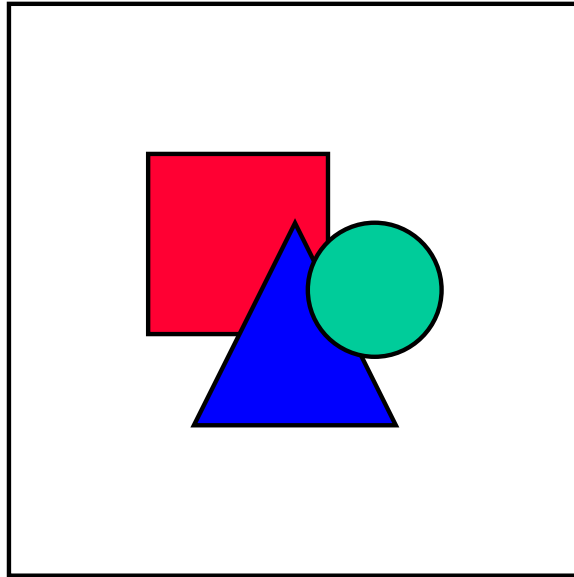

You can only change the status for a piece of equipment if the equipment type is PRT-relevant.

- **Changing the cycle modification factor**

The cycle modification factor specifies the inspection interval in a preventive maintenance plan. For example, the results of an inspection may indicate that a piece of equipment is currently still in order. In all likelihood, however, the equipment will require maintenance before the next regularly scheduled inspection. In this case, you can change this factor when you make the usage decision to shorten the inspection interval.

When you save the usage decision code, the system displays the current cycle modification factor. If you change the current factor, the system updates the factor in the preventive maintenance plan.



By copying the function module for the follow-up action, you can implement your own logic for changing the cycle modification factor (for example, on the basis of your inspection results).

- **Updating measurement documents**

If you have defined measuring points for your piece of equipment, the system can automatically create measurement documents for each measuring point. When the system executes this follow-up action, the results of the calibration inspection are automatically recorded in new measurement documents. These documents are included in the equipment history.

The system only executes this function if the master inspection characteristics in the maintenance task list and the measuring point master records are linked together by class characteristics in the *Classification System*.



As an alternative, you can use the function in QM to display the [results history \[Ext.\]](#) for equipment or functional locations.

Usage Decision for Inspection Lot

- **Completing a maintenance order technically**

This function completes the maintenance order that triggered the creation of the inspection lot for the calibration inspection. A maintenance order is completed technically when all planned tasks for the order have been performed (for example, the calibration inspection and all associated activities have been completed). Once an order has been completed technically, it must then be completed from a business standpoint.



You can also [complete a maintenance order manually \[Page 26\]](#).

See also:

[Automatic Usage Decision \[Ext.\]](#)

[Making the usage decision for a list of inspection lots \[Ext.\]](#)

Making the Usage Decision Manually

1. Choose *Logistics* → *Quality management* → *Test equipment management* → *Calibration inspection* → *Usage decision* → *Record*.

The initial screen with the functions for the usage decision appears.

2. Enter the number of the inspection lot.
3. Choose *Usage decision*.

The characteristic overview screen for the usage decision appears.

4. Use the possible entries help to choose an appropriate code for the usage decision.

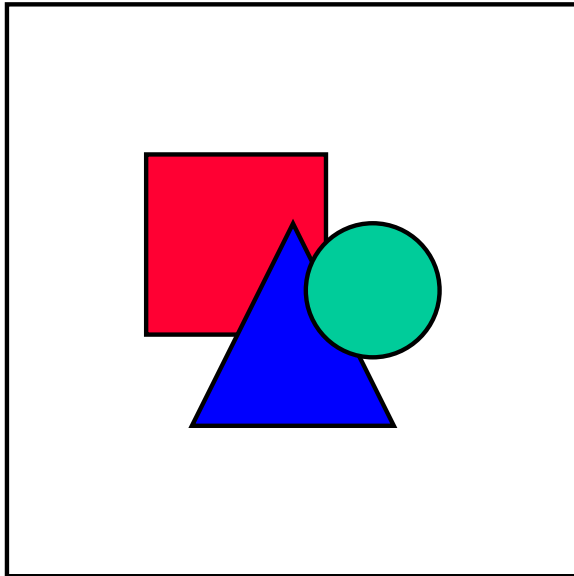

You must use the possible entries help to choose the usage decision code because the code key may not be unique.

The code group and short text for the selected usage decision code is displayed.

5. Save the data.
A dialog box containing information and proposed values for the automatic follow-up actions is displayed.
6. Confirm or change the proposed values.

Completing a Maintenance Order Technically

Completing a Maintenance Order Technically

Prerequisites

The procedure for completing a maintenance order involves the following steps:

- **Completing the order technically**
You usually complete a maintenance order technically once the planned maintenance work (for example, the calibration inspection) has been completed.
- **Completing the order from a business standpoint**
You complete a maintenance order from a business standpoint when you no longer expect any costs to be posted to the order.

To complete an order from a business standpoint, you must first complete the order technically. This procedure only describes how to complete a maintenance order technically.

For more information about completing maintenance orders from a business standpoint or about maintenance orders in general, see [Maintenance Orders \(PM-WOC-MO\) \[Ext.\]](#).

Procedure

1. Choose *Logistics* → *Quality management* → *Test equipment management* → *Calibration inspection* → *Order* → *Change*.

The initial screen for changing an order appears.

2. Enter the number of the maintenance order you want to complete.
3. Choose *Continue*.

The header screen for the maintenance order appears.

4. Choose *Order* → *Functions* → *Complete (techn.)*.

A dialog box for completing the order appears.

5. Choose *Complete*.

The maintenance order is completed technically, the appropriate status is set, and the order is saved.

Result

You can now complete the maintenance order from a business standpoint, if necessary.