

# Project Information System



**Release 4.6C**



## Copyright

© Copyright 2001 SAP AG. All rights reserved.

No part of this publication may be reproduced or transmitted in any form or for any purpose without the express permission of SAP AG. The information contained herein may be changed without prior notice.

Some software products marketed by SAP AG and its distributors contain proprietary software components of other software vendors.

Microsoft<sup>®</sup>, WINDOWS<sup>®</sup>, NT<sup>®</sup>, EXCEL<sup>®</sup>, Word<sup>®</sup>, PowerPoint<sup>®</sup> and SQL Server<sup>®</sup> are registered trademarks of Microsoft Corporation.

IBM<sup>®</sup>, DB2<sup>®</sup>, OS/2<sup>®</sup>, DB2/6000<sup>®</sup>, Parallel Sysplex<sup>®</sup>, MVS/ESA<sup>®</sup>, RS/6000<sup>®</sup>, AIX<sup>®</sup>, S/390<sup>®</sup>, AS/400<sup>®</sup>, OS/390<sup>®</sup>, and OS/400<sup>®</sup> are registered trademarks of IBM Corporation.

ORACLE<sup>®</sup> is a registered trademark of ORACLE Corporation.

INFORMIX<sup>®</sup>-OnLine for SAP and Informix<sup>®</sup> Dynamic Server<sup>™</sup> are registered trademarks of Informix Software Incorporated.

UNIX<sup>®</sup>, X/Open<sup>®</sup>, OSF/1<sup>®</sup>, and Motif<sup>®</sup> are registered trademarks of the Open Group.







HTML, DHTML, XML, XHTML are trademarks or registered trademarks of W3C<sup>®</sup>, World Wide Web Consortium, Massachusetts Institute of Technology.

JAVA<sup>®</sup> is a registered trademark of Sun Microsystems, Inc.

JAVASCRIPT<sup>®</sup> is a registered trademark of Sun Microsystems, Inc., used under license for technology invented and implemented by Netscape.

SAP, SAP Logo, R/2, RIVA, R/3, ABAP, SAP ArchiveLink, SAP Business Workflow, WebFlow, SAP EarlyWatch, BAPI, SAPPHIRE, Management Cockpit, mySAP.com Logo and mySAP.com are trademarks or registered trademarks of SAP AG in Germany and in several other countries all over the world. All other products mentioned are trademarks or registered trademarks of their respective companies.

## Icons

Icon	Meaning
	Caution
	Example
	Note
	Recommendation
	Syntax
	Tip

## Contents

<b>Project Information System .....</b>	<b>6</b>
<b>Working with the Information System.....</b>	<b>8</b>
<b>Selection Criteria and Representation .....</b>	<b>10</b>
Profiles in the Information System .....	13
Changing Profiles/Variants.....	14
Specifying Value Ranges.....	15
Specifying Selection Options .....	16
Entering Selections .....	17
Creating Selection Versions.....	18
Checking the Selection Scope .....	20
Selecting Fields.....	21
Sorting and Grouping.....	22
<b>Accessing Reports in Background Processing.....</b>	<b>23</b>
Working with Variants .....	24
Using Variants in Batch Processing.....	25
<b>Project Hierarchy Display.....</b>	<b>27</b>
Example: Project Information System Hierarchy .....	29
Example: Dynamic Selections.....	31
<b>Currencies in the Information System .....</b>	<b>33</b>
<b>Old Information System Functions.....</b>	<b>34</b>
<b>Some Advice on Information System Performance.....</b>	<b>35</b>
<b>Technical Project Reports .....</b>	<b>37</b>
<b>Important Technical Note Regarding the Use of Overviews.....</b>	<b>38</b>
45B: Overviews in the Information System .....	39
45B: Working with Overviews .....	41
45B: Structure Overview .....	42
45B: Calling Up Individual Overviews Directly.....	44
Easy Access: Overviews in the Information System.....	45
Easy Access: Working with Overviews.....	47
Easy Access: Structure Overview.....	48
Easy Access: Calling Up Individual Overviews Directly.....	50
Statistics.....	51
<b>Graphics in the Information System .....</b>	<b>52</b>
PS Graphics .....	53
Structure Graphic .....	54
Work Breakdown Structure Graphic .....	55
Network Structure Graphic.....	56
Gantt Chart.....	57
SAP Business Graphics.....	58
Portfolio Graphic .....	59
Period Breakdown.....	60
<b>Confirmations .....</b>	<b>61</b>
Entering Confirmations in the Information System .....	62
Creating a Pool of Confirmations in the Information System .....	63
Deleting a Pool of Confirmations in the Information System .....	64

Creating a Workflow for Confirmations .....	65
<b>Accessing Capacity Evaluations .....</b>	<b>66</b>
<b>Accessing Cost Reports from the Structure Overview .....</b>	<b>67</b>
<b>Branching to Other Information Systems .....</b>	<b>68</b>
<b>Commercial Project Reports .....</b>	<b>69</b>
<b>Reports on Project Materials.....</b>	<b>71</b>
<b>Hierarchy Reports: Costs, Revenues, and Payments .....</b>	<b>72</b>
Example: Creating Forms .....	75
Changing Forms.....	79
Example: Creating Reports .....	80
Assigning Reports .....	82
Creating Variants for Reports.....	83
Running Hierarchy Reports.....	84
Hierarchy Structure and the Effects on Values Displayed .....	86
Standard Hierarchy Reports.....	87
<b>Cost Element Reports .....</b>	<b>89</b>
Report Painter Reports .....	90
Accessing Cost Element Reports .....	91
Functions for Executing Cost Element Reports .....	93
Branching to the Line Item Report .....	95
Standard Cost Element Reports .....	96
<b>Line Item Reports .....</b>	<b>98</b>
Accessing Line Item Reports .....	101
Plan Line Items for Costs and Revenues.....	103
<b>Displaying CO Documents .....</b>	<b>104</b>
<b>Project Summarization .....</b>	<b>105</b>
<b>Summarization Hierarchies .....</b>	<b>107</b>
<b>Summarization in Projects .....</b>	<b>109</b>
<b>Executing Inheritance Runs .....</b>	<b>112</b>
<b>Executing Project Summarization .....</b>	<b>114</b>
<b>Accessing Project Summarization Reporting .....</b>	<b>116</b>
<b>Standard Summarization Reports .....</b>	<b>117</b>
<b>Project Summarization Using Classification.....</b>	<b>118</b>
Characteristics .....	120
Displaying Reference Characteristics.....	122
Defining Your Own Characteristics.....	123
Displaying Characteristics for a Class .....	124
Alternative Hierarchies in Summarization .....	125
Executing Summarization Using Classification.....	126
<b>Transferring Data to EIS .....</b>	<b>128</b>
<b>Transferring Data to the Business Information Warehouse .....</b>	<b>130</b>
<b>Reports on Resources .....</b>	<b>131</b>
<b>Selection Criteria .....</b>	<b>132</b>
<b>Defining Selection Criteria .....</b>	<b>133</b>
<b>Starting Evaluations.....</b>	<b>134</b>

## Project Information System

### Purpose

The Project Information System is a flexible, comprehensive information system you can use to monitor and control your project data. You can evaluate individual projects, partial projects, or multiple projects. The system includes overview reports and reports offering various degrees of detail. The Project Information System is designed to meet the needs of both project management and ordinary project personnel.

### Integration

You need this component to analyze and control your project.

You can transfer data from the project information system to the SAP Business Information Warehouse (BW). BW is a management information system that gathers information from the various areas in your business and makes them available for management reports

### Features

You can run recurring standard reports and create your own reports to meet your specific information needs and tasks. You can display all data in the information system immediately after entering it or can run the reports in the background.

Report evaluation includes a wide range of functions. For example, you can branch to other reports for more detailed information, send reports via Mail, or print them.

The standard also includes reports offering different degrees of detail, summarizations, and views of current data, version data, and archive data for:

- Structures
- Controlling
- Progress
- Resources
- Material

The following table will help you decide which report type is best for you in each case:

To:	Choose:
Analyze operative or organizational data from different viewpoints, bearing your project structure in mind	The structure reports in <a href="#">technical project reports [Page 37]</a>
Obtain detailed information on selected objects, such as WBS elements, activities, or confirmations	The appropriate individual overview in <a href="#">technical project reports [Page 37]</a>
View a hierarchical overview of your cost and payment data	<a href="#">Hierarchy Reports: Costs, Revenues, and Payments [Page 72]</a>
Evaluate detailed information at cost element level (example: reconciliation reports)	<a href="#">Cost Element Reports [Page 89]</a> .

Trace the origin of your costs at document level	<a href="#">CO line item reports [Page 98]</a>
View detailed information at area level on, for example, purchase orders or capacities	<a href="#">Reports on Resources [Page 131]</a>
View information on the progress of your project	The reports described in <a href="#">Evaluating Project Progress [Ext.]</a>
View information on claims relating to your projects	The reports described in <a href="#">Evaluating Claims [Ext.]</a>
Evaluate project data, summarized, per different viewpoints	<a href="#">Project summarization [Page 105]</a>
Obtain information on the materials situation in your projects	<a href="#">Reports on Project Materials [Page 71]</a>

## Working with the Information System

### Prerequisites

You require various profiles in the Project Information System. You can:

- Maintain profiles in the Project System IMG
- Maintain profiles by choosing *Tools* in the information system menu
- Make changes to profiles from the report.

These changes can apply to the current report access only or they can be permanent.

For more information, see [Profiles in the Information System \[Page 13\]](#) and the documentation in the *Information System* section of the Project System IMG.

### Procedure

1. In the SAP Easy Access Menu, choose *Logistics/Accounting* → *Project System* → *Information System*.

The system then offers a number of report options, as follows:

#### Structures

Here you can access the structure overview, individual overview, where-used lists, and change documents.

#### Financials

This section includes reports on cost, revenues, and payments. You can also access the document display, line item displays, and summarization reports.

#### Progress

This section includes reports on progress analysis, milestone trend analysis, and confirmation.

#### Resources

This section includes reports on capacities and workforce planning.

#### Material

This section includes reports on stock, purchasing, and production.

#### Tools

This section contains a number of tools aimed at making it easier to work with the information system. These include selection tools, intranet facilities, and a tool for transferring data to the Executive Information System (EIS).

2. Select the desired report and choose *Execute*.

The system will ask you to specify particular data when you first access the information system, depending on which report you are using, as follows:

- The PS info profile if you are calling up technical project reports

Working with the Information System

- The database profile and controlling area if you are calling up commercial project reports

Certain reports may also ask you to specify other data, such as an application class.

3. This brings you to the initial screen for the report you have selected. You can enter data selection constraints here.
4. To improve system performance, [check the selection \[Page 20\]](#) and, if necessary, execute the report in background processing.

## Result

The system determines the objects and data in light of the various profiles and selection criteria, and displays them in the report as appropriate. You cannot select further data from the database within the evaluation.



You use profiles to stipulate which object type is displayed. You use the selection criteria to specify the object selection conditions.

The view defined in the profile determines how the data appears in a hierarchy.

**See also:**

[Selection Criteria and Representation \[Page 10\]](#)

[Project Hierarchy Display \[Page 27\]](#)

If you want to use the data selection criteria for later evaluations or want to call up the report in background processing, you can store the settings as a [variant \[Page 24\]](#).

If you always use the same profiles, you can define user parameters for them. You will not then have to specify these parameters when you access the information system. To store user parameters, choose *System → User profile → Application values*.

You can define the following user parameters for the profiles:

User Parameter	Parameter ID	For...
PS info system profile	PFL	Technical project reports
Database profile	PDB	Commercial project reports
Project view	PRV	All project reports

## Selection Criteria and Representation

# Selection Criteria and Representation

## Use

When you access a report, you use profiles and selection criteria to define the scope and structure of the data selected. This means you can obtain a project evaluation covering a whole project, a project version, or an individual WBS element and containing only the objects and data in which you are interested.

You use profiles to stipulate:

- Which objects are selected
- The view in which the data is displayed
- How the fields in the overviews for the technical project are displayed

The data in the information system is based on the Project System logical database (PSJ). For more information on the logical database, read the documentation on report program *SAPDBPSJ*.

## Prerequisites

You must first maintain the profiles relevant to the information system. For more information, see [Profiles in the Information System \[Page 13\]](#) and the documentation in the *Information System* section of the Project System IMG.

## Features

### Object Selection

Choose *DB profile* to define which objects are selected from the database. The appearance of the initial screen in the information system will vary according to what you enter here.



In the database profile, if you stipulate that you do not want to select components, the information system initial screen does not include the *Materials in network* field.

If you stipulate that you want to select version data, the information system initial screen displays additional fields for specifying the origin of data.

Having used the database profile to define which objects are selected when the report is accessed, you can use the initial screen to restrict the object selection using:

- Values

If you specify individual values or a [value range \[Page 15\]](#), the system selects only the objects with the appropriate values. You can use [selection options \[Page 16\]](#) to restrict the range of data to, for example, values which are less than, more than, or just not the same as, the specified values. You can select data for the following objects:

- Project
- WBS element
- Network/order

## Selection Criteria and Representation

- Activity
- Materials in networks

The default value is "no selection".

- Status selection profile

You can use the status selection profile to restrict selection to objects which meet the requirements for a particular combination of statuses. You can maintain status selection profiles for the following objects:

- Project definition
- WBS element
- Network/order
- Activity

The objects are selected hierarchically - meaning that subordinate objects are not selected unless the relevant superior objects fall within the scope of the status selection profile.



You release the status selection profile for use in project definitions and enter the project definition as a selection criterion when you access the report. The project definition has the status *Partially released*; the subordinate objects have been released. The project definition does not meet the requirements of the status selection profile. In this example, no objects are selected in database selection.

You release the status selection profile for use with activities. The system selects the released activities regardless of whether superior objects in the hierarchy satisfy the requirements in the status selection profile.

- Effects of dynamic selections

[Dynamic selections \[Page 17\]](#) are a means of restricting the data selection per particular criteria, such as profit centers, persons responsible, or date of last change.



By entering suitable selection criteria, you reduce the amount of data selected by the logical database. This can significantly improve system performance when you access reports.

## Data Presentation (Project View)

The data selected by the database can be displayed in different hierarchies (views).

You stipulate the hierarchy using the project view. The project view is defined in the database profile. You can display the data in the information system as viewed from:

- Project structure
- Profit center hierarchy
- Cost center hierarchy

## Selection Criteria and Representation

- Characteristic hierarchy
- Capital investment program
- Sales and Distribution (SD) - for example, by sales order
- Characteristic hierarchy with single-level object list
- Hierarchy you define yourself

For more information on presenting the data as viewed from the project structure, read [Displaying the Project Hierarchy \[Page 27\]](#).

## PS Info System Profile

The information system profile combines all the profiles you need to work with technical project reports. As well as the database profile, it contains, for example, profiles for displaying the structure overview and individual overviews.



To work with the commercial project reports, you do not need an overall profile. The database profile is enough.

## Activities

When you access a report from the database, the system selects the data which exactly meets the selection criteria. You cannot select additional data within the report evaluation.

You can store the selection criteria you entered as a variant and use it for further evaluations or for [accessing reports in background processing \[Page 23\]](#).

[Create selection versions \[Page 18\]](#) so that you can access the technical project reports quickly. A selection version contains all the objects and data matching the selection criteria when you created the version.

## Profiles in the Information System

You maintain profiles in the Project System IMG. When you access a report, you can change the profiles temporarily in the Information System initial screen.

### Database Profile

You use profiles to stipulate:

- View in which the data is displayed - for example, by profit center
- Origin of the data

You can specify which data the system should look for in the database or archive.

- Operative data
- Version data
- Archive data
- Standard structures
- Which objects are selected by the database

By specifying selection criteria in the database profile for objects, you can restrict the scope of the data selected. For example, you can stipulate that only the WBS elements and all activities assigned to a particular WBS element are selected.



You can save any temporary changes made to the database profile for report evaluation in the technical project reports.

### PS Info System Profile

The PS info system profile combines all the profiles you require for the structure overview and individual overviews in the technical project reports. You use the PS info system profile to determine:

- The database profile and, with it, the project view
- How the fields in the information system overviews are displayed

You can choose a different PS info system profile in the information system initial screen, but cannot change the profile itself here.

For detailed information on profiles, refer to the *Information System* component in the Project System IMG.

---

**Changing Profiles/Variants**

## Changing Profiles/Variants

- The initial screen offers two options in the initial screen:
  - *Other PS Info Profile*
    - You can specify a profile other than the default.
  - *Change DB Profile Temporarily*
- Once in the evaluation, first use the *Choose Functions* facility to include the *Profiles* pushbutton. The following options are then available:
  - *Get Profile/Variant*
  - *Save Profile*
  - *Set Profile*

## Specifying Value Ranges

### Procedure

1. Enter an individual value or a value range for the field in question.
2. If you want to select several values or a value range, enter the lower limit in the left-hand column and the upper limit in the right-hand column.
3. If you want to use multiple selection, click the arrow to the right of the relevant row. The system displays a dialog box in which you can enter further values or value ranges.

The dialog box includes four tab pages, which you can use as follows:

Use the *Single value selection* tab page with the green traffic signal to specify further single values for selection.

Use the *Ranges* tab page with the green traffic signal to specify further value ranges for selection.

Use the *Single value selection* tab page with the red traffic signal to exclude single values from the selection.

Use the *Ranges* tab page with the red traffic signal to exclude value ranges from the selection.

## Specifying Selection Options

### Procedure

1. Position the cursor on the appropriate field and choose  *Selection options*.  
The system displays a dialog box where you can maintain the selection options for the field.
2. Choose the desired option.
3. To select all the values except the one specified, click the green *Select* traffic signal. This then switches to red (*Exclude from selection*).

## Entering Selections

### Prerequisites

To use dynamic selections, you must enter a selection of your choice in a field - for example, a WBS element or a wild card.

### Procedure

1. Enter relevant data on the initial screen, such as a WBS element and/or change the selection options from *single value* to *not equal* for further WBS elements.
2. Choose *Edit* → *Dynamic selections*.  
The dialog box *Field selection for dynamic selections* appears.
3. Select the appropriate fields and choose *Dynamic selections*.  
A selection screen appears.
4. Enter the data relevant for the dynamic selection, such as a profit center name.
5. Save your input.

### Result

The function line in the initial screen tells you that dynamic selections are active. The system only selects the data which comply with the dynamic selections - for example, only projects which are assigned to a particular project manager.



The hierarchy presentation for dynamic selection is determined largely by the settings in the database profile. If you have set the user-defined selections indicator in the database profile, this may mean that only part of the hierarchy, not all of it, is selected. For example, if a WBS element on hierarchy level 2 is not selected, any elements subordinate to it are displayed in level 2, not level 3. See [Example: Dynamic Selections \[Page 31\]](#).

## Creating Selection Versions

# Creating Selection Versions

## Use

In large projects, we recommend you save the evaluation as a **selection version**. A selection version contains all data matching your selection criteria, including dynamic selections.

The main advantage of working with selection versions is that the data is read from a special table when you access the report; it does not have to be selected by the database. This means you can view the evaluation quickly at any time.

You can create selection versions in background processing and call up the evaluation later.



Selection versions contain only the data that existed when they were created. Changes made since then are not included.

## Prerequisite

You can only create selection versions for technical project reports.

## Creating Versions in the Initial Screen

Before you call up the project evaluation, you can create a selection version in the information system initial screen.

1. Choose *Evaluation* → *Save selection version*.  
The *Save Selection Version* dialog box appears.
2. To create the selection version online, choose *No*.
3. Enter a name and the number of days you want to keep the selection version before it is automatically deleted.
4. You can set the protected indicator to prevent anyone but yourself from deleting the selection version before the deletion date.
5. Choose *Continue*.
6. The system automatically creates a selection version. You then branch to the initial screen.

## Creating Selection Versions in the Background

Before you call up the project evaluation, you can create a selection version in the background in the information system initial screen. This may be necessary for large projects, to avoid time-out problems.

1. Choose *Yes* in the *Save Selection Version* dialog box.  
The system then displays the *Background Print Parameters* dialog box.
2. Enter a title for the background job. This will also be the name of the selection version. The system automatically sets the number of days until deletion to 30 and sets the *protected* indicator.
3. In the *Start Time* dialog box, schedule a time for the background job to run.

4. Choose *Save*.

You get the message: "Background job scheduling generated for program..."

For more information on background processing, refer to: *BC Computing Center Management System*.

## Creating Versions in the Evaluation

In the evaluation, you can create selection versions either by choosing *Evaluation* → *Save selection version* or when you leave the evaluation. When you leave the evaluation, you can save the current evaluation as a selection version in the *Leave Information System* dialog box.

## Result

Once you have saved selection versions they are available to all those authorized to use your Project System installation.

When you call up the selection version, the system automatically checks your authorization and only displays the data you are authorized to see.



The system cannot read old selection versions after you install a new maintenance level. Do not use the selection versions to document the state of the project. The project versions are available for this purpose.

---

**Checking the Selection Scope**

## Checking the Selection Scope

### Prerequisite

You are in the information system initial screen and have specified the selection criteria.

### Procedure

Choose  *Test selection scope*.

### Result

The system displays a list, sorted by object type, showing the number of objects selected. You can use these statistics to decide whether you can reduce the load on the system by:

- Selecting fewer project elements or a narrower range of data
- Executing the evaluation in the background

#### See also:

[Accessing Reports in Background Processing \[Page 23\]](#)

## Selecting Fields

### Selecting Individual Fields

1. Choose *Display Variant* or *Layout*.  
The *Select Fields* dialog box appears. The left half of the box shows the fields already selected for display
2. To add fields to the display, select from the list in the right half of the box, then press the black arrow pointing left.  
The fields then appear in the left half of the box and will appear in the display.
3. To remove fields from the display, select from the list in the left half of the box, then press the black arrow pointing right.  
The fields are deleted from the left half of the box and appear again on the right. They will not appear in the display.
4. To **change the sequence** of the fields,
  - First select the desired field, then move it to where you want it to be
  - Choose *Move*.
  - The field is inserted **above** the current position of the cursor.
5. When you have finished, accept your selection.

---

**Sorting and Grouping**

## Sorting and Grouping

### Sorting

1. If you want to specify only one sort criterion, select the field by which the data is to be sorted.  
*Choose **Sort in ascending order** or **Sort in descending order**.*
2. The system displays the selection list in which you can choose the field you want to sort by. Choose the field as appropriate.
3. The data is sorted based on the criteria you specified.

### Grouping

1. *Choose **Group in ascending order** or **Group in descending order**.*
2. The system displays the selection list in which you can choose the fields you want to group by. Choose the fields as appropriate.
3. The data is grouped based on the criteria you specified.

## Accessing Reports in Background Processing

### Use

You can schedule reports in background processing for the purpose of evaluating your project results at intervals. You should always do this when there is a lot of data to evaluate; otherwise, system performance may be adversely affected.

### Prerequisites

You must define variants for use in report background processing.

#### See also:

[Working with Variants \[Page 24\]](#)

[Creating Variants for Reports \[Page 83\]](#)

### Features

You can schedule the report access for one given point in time or periodically. To this end, you must save the selection criteria in variants.

For more information on background processing, refer to: *BC Computing Center Management System*.

### Activities

To run the drilldown reports in background processing, go to the Project System part of the Easy Access menu and choose *Information System* → *[Report you want]*. Then, in the initial screen, choose *Evaluation* → *Execute in Background*.

## Working with Variants

### Use

You can use variants to define the selection options for evaluations you use frequently. You require variants for reports you want to schedule for periodic background processing.

### Prerequisites

Before creating a variant, you must maintain the selection options in the Information System initial screen.

For more information, read [Creating Variants for Reports \[Page 83\]](#).

### Procedure

- To save the settings you have entered in the initial screen as a variant, choose *Goto* → *Variants* → *Save as variant*.
- To access existing variants, choose *Edit* → *Get variant*.
- To delete variants, choose *Goto* → *Variants* → *Delete*.

### Result

When you call up a variant, the system automatically enters the selection variant selection options in the information system initial screen.

## Using Variants in Batch Processing

### Use

The SAP system includes a central option you can use to access reports from the structure information system for background processing.

### Prerequisites

You must first store a selection variant in the online access for the relevant transaction. If you have not already created one, you can do so directly from the transaction.

### Procedure

1. Go to the Easy Access menu and choose *Project System* → *Information System* → *Tools* → *Structure/Individual Overviews* → *Batch Variants*.

The system displays the *Choose Overview and Variant* dialog box.

2. Select the report you want to carry out and enter the appropriate selection variant. Choose  *Change/Create* to create a new variant or edit the existing one you entered.



To carry out progress analysis, choose the structure overview in this dialog box and activate the *Progress Analysis* checkbox in the next screen.

3. Confirming your entry brings you to the *Project Info System: Create Batch Variants* screen.
4. Activate the activity you require by pressing the corresponding pushbuttons. A green checkmark (  ) appears in each function you activate.

To deactivate a pushbutton, press it again. The checkmark then disappears.

The pushbuttons include *Maintain Variant*, which you can use to access the functions for changing the variant you entered in the dialog box.

### Pushbutton Details

#### Send Mail

- *Full Name*: Enter the recipient's user ID here  
You can enter a distribution list as well as this or instead of it.
- Assign the attributes *Express* or *ToDo* if you need them.

#### Confirmation Pools

- *Delete*: Enter the number of the confirmation pool you want to delete.
- *Create*: Enter a number and description for the new confirmation pool.
- *Workflow*: Enter the number and description, then choose the object type of the receiver by setting the appropriate radio button. Example: *Role*.

## Using Variants in Batch Processing

### Export to MS Access

- Specify the PC path name for storing the files, along with "from" and "to" dates for transferring the calendar there.
- Use the *Create Table* option to stipulate that tables are to be created for the data downloaded to MS Access.



### Remote Confirmation

- The requirements are the same as for MS Access. In addition, you can stipulate that the work breakdown structure or master data tables are transferred too.

### Project Version

- *Delete*: Enter the name of the project version you want to delete.
- *Save*: Enter the version key, version group, and a description. If you want the system to select a number for you, check *Next Open Number* instead of entering a version key.

### Mass Change

1. Having activated the option, press *Enter Field Values for Mass Changes*.
2. Select the tab page for the corresponding master data. The right-hand side of the selection window shows the fields you can choose from. Copy the ones you want by marking them individually and pressing the left-pointing arrow. Press the double arrow to copy them all.
3. When you have finished selection, use the  *Check* pushbutton to verify that your entries comply with the restrictions for the relevant data element.
4. Complete selection after the check by pressing  *Adopt*.

## Result

With selection complete, you can now execute the report. Choose *Program* → *Execute* to do this in the foreground, or *Program* → *Execute* in background.

## Project Hierarchy Display

The hierarchy display depends on:

- Objects selected by the database
- Project view selected
- Constraints in the object display

This means that the hierarchy depends on various factors, such as authorizations, the database profile, user-defined selections, and filters set.

### View from the Project Structure

If you use the hierarchy display as viewed from the project structure, note the following:

- The network header assignment to the project definition or WBS element is not inherited by the activity or activity element. You must maintain the assignment specifically in the activities.
- The network header assignment to a WBS element has priority over an assignment to a project definition.
- Networks which are not assigned to a project definition selected for display in the information system are displayed at the highest level.
- The hierarchy display for the WBS elements in the report is determined by the relationships between them.

If the commercial evaluation indicator is active in the database profile, note the following:

- Only the network header or the activities and activity elements are displayed, depending on whether the network is header-assigned or activity assigned.
- Material components are only displayed if they are part of valuated project stock. In this case, they are directly subordinate to assigned WBS elements.

[Example: Project Information System Hierarchy \[Page 29\]](#)

### Effects of Authorizations

The project hierarchy is always displayed in its entirety. Objects for which you do not have authorization will be shown with only minimal data.

The following objects are displayed if you have no authorization:

1. Project definition
2. WBS element
3. Network header
4. Activity
5. Material component
6. Sales and distribution document

## Project Hierarchy Display

Project texts and production resources and tools, for example, are not displayed.

### Effects of Dynamic Selections

If you use dynamic selections to exclude elements from the evaluation, the system does not select them from the database. Depending on the database profile, this may mean that the hierarchy is not displayed in full. The system automatically hides the levels with no elements. For example, if a superior WBS element is hidden, the subordinate level 3 WBS element appears in level 2. The costs of the hidden WBS element are not rolled up.



Dynamic selections **temporarily** alter the **appearance** of the project hierarchy in the evaluations. They have no effect on the hierarchy itself.



The effect of the dynamic selections on object selection is largely dependent on the settings in the database profile.

[Example: Dynamic Selections \[Page 31\]](#)

### Effects of Filters

Filters have no effect on database selection, but temporarily hide elements in the evaluation. Superior elements which do not satisfy the filter criteria can, at your option, be displayed with minimal data or not at all. There is no shifting of hierarchy levels.

## Example: Project Information System Hierarchy

All the indicators in the database profile except *Commercial eval.* are activated.

Sample project PD-A has the following structure:

Description	Level
PD-A	0
WBS-A-1	1
WBS-A-1-1	2
WBS-A-1-2	2

Networks NW and NW1 are assigned to the project. The networks and activities are assigned to the project as follows:

Activity	Allocation
NW1	PD-A
NWA10	Not assigned
NWA20	Not assigned
NW	PD-A and WBS-A-1-1
NWA10	WBS-A-1-1
NWA20	WBS-A-1-2

There is a material component for activity NWA20.

The graphic below shows the hierarchy setup as viewed from the project structure.

Example: Project Information System Hierarchy

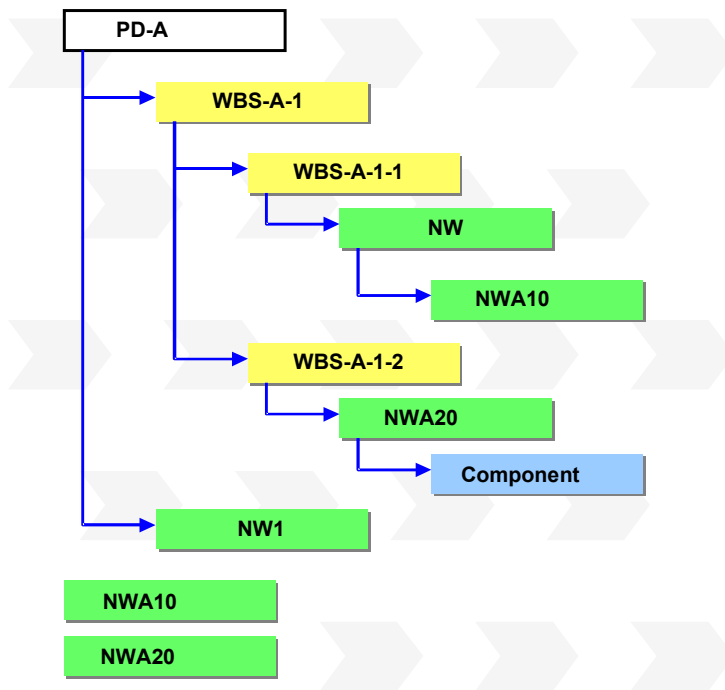

## Example: Dynamic Selections

We will look at how dynamic selections work in a sample project, called WBS-A.

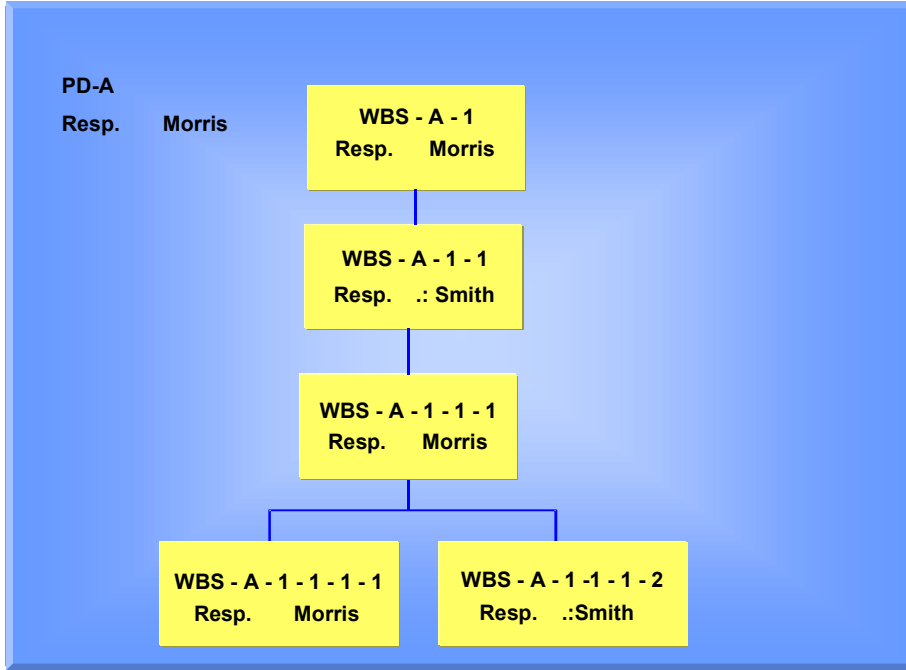

### Example 1

You select the project WBS-A taking account of the dynamic selections entered for project manager Morris. They are maintained for the project and WBS elements. You have activated *Dynamic sels* and *Incl.hierarchy* in the database profile.

As a result, the project reports are presented as follows:

Description	Level	Responsible person
WBS-A	0	Morris
WBS-A-1	1	Morris
WBS-A-1-1-1	2	Morris
WBS-A-1-1-1-1	3	Morris

The costs for WBS element WBS-A-1-1 and WBS-A-1-1-1-2 are not totaled up to WBS element WBS-A-1.

### Example 2

Deactivate the *Dynamic sels* in the database profile; the subordinate WBS elements are included in the selection. The costs are totaled up.

As a result, the project reports are presented as follows:

**Example: Dynamic Selections**

Description	Level	Responsible person
WBS-A	0	Morris
WBS-A-1	1	Morris
WBS-A-1-1	2	Smith
WBS-A-1-1-1	3	Morris
WBS-A-1-1-1-1	4	Morris
WBS-A-1-1-1-2	4	Smith

## Currencies in the Information System

### Use

All the currency-dependent data in the Project System is managed in three different currencies in parallel:

- Controlling area currency
- Object currency
- Transaction currency
- Planning also takes account of the business transaction currencies. For example, for an externally-processed activity, the system takes the currency from the purchasing info record. If no currency has been maintained in the purchasing info record, you can maintain it manually in the business transaction. The planning finance flow is always displayed in the project by currency.

Every amount in the project is translated as appropriate when you enter it and recorded in the database in all three currencies. You stipulate the currency translation rates in the Project System implementation guide.

### Integration

The commercial information system offers reports in any currency you want, in addition to those described above. The system translates the data using the latest rates.

To customize the rates as required, go to the Project System IMG and choose *Information System* → *Costs/Revenues Information System* → *Hierarchy Report* → *Currency Translation* → *Define Currency Translation Keys*.

In the report list, choose  *Currency Translation* to have the system translate the respective currencies at the rates configured.

---

**Old Information System Functions**

## Old Information System Functions

### ABAP List Viewer

If you have been using the project information system for some time, you will be familiar with most of its functions, particularly those you have used most often. However, when upgrading to Release 4.6C, you may find that some functions you used before are no longer available.

The structure overview and individual overviews are now based on ABAP List Viewer (ALV) technology, which cannot handle certain of the functions previously available. The functions affected are listed below.

#### In the Structure Overview

- Send evaluation
- Compare columns
- Summarization
- Hitlist
- Clear hierarchy
- Representing values as percentages
- Hierarchy ID
- Maintaining header/title texts

#### In the Individual Overviews

- Send evaluation
- Compare columns
- Hitlist
- Representing values as percentages
- Hierarchy ID
- Maintaining header/title texts
- Changing groups

### Version Data

As of Release 4.6, we deliver most hierarchy reports minus the option of selecting data from project versions. However, if you still need to do this, note 309701 details a procedure that can help.

## Some Advice on Information System Performance

Projects generate a lot of data. Processing large amounts of data in the information system can adversely affect system performance. This topic aims to give you some advice on how you can get around this problem.

### Selection

The less data the system needs to select for processing, the quicker that processing will be and the sooner your report will be displayed. You can achieve this by restricting the data selected in the following ways:

- Use selection variants. If you later need to see this data again, save time by entering the variant name. The system does not then need to search the database again for this data, but simply displays the variant, with the data updated as necessary.
- If you are not using variants, you can still make processing in Report Writer faster by:
  - Choosing *Variation* in the selection screen to determine the level to which the data displayed in the report is broken down. We recommend that you do not use the *Single value* option.



Remember that excluding objects from the report display has no effect on the values stored for these objects in the system. The objects are simply not shown.

- Limiting the number of levels accessed by the report when you define the report in the Report Painter. For more information, see [Report Painter Reports \[Ext.\]](#) in the FI-SL Special Ledger documentation.
- In the report itself, choose *Edit* → *Variation*, then select no detailing.
- To improve system performance when accessing line item reports, choose *Further settings* and set the *Variant fields only* indicator. The result of this is that only those fields needed for the current variant are selected from the database. If you do this, however, only limited changes to the chosen display variant are possible in the line item display.
- Configure the database profile as appropriate.

For detailed information on what this involves, see [Profiles in the Information System \[Page 13\]](#).

### Dynamic Selections

If you use dynamic selections to exclude elements from the evaluation, the system does not need to select them from the database, thereby making processing faster.

While this may mean that, for example, the hierarchy is not displayed in full, dynamic selections alter only the appearance of the project hierarchy in the evaluations. They make no actual changes to the hierarchy.

**See also:** [Example: Dynamic Selections \[Page 31\]](#).

### Filters

You can narrow down the data to be viewed by setting filters, for example, if you only want to see the dates of networks for which a particular project manager is responsible, or only those projects that have a certain priority.

---

**Some Advice on Information System Performance**

Filters have no effect on the range of data selected, so they do not speed up report processing. They can, however, make a report easier to read as they hide data you do not want to see.

When you remove the filters, the display shows all the data selected, without your having to leave the evaluation first.

**Value Categories**

In the hierarchy reports, the system evaluates the cost, revenue, and payment data, based on value categories. You can improve system performance when running such evaluations by combining cost/revenue elements and commitment items in value categories.

**Summarization**

If you want to see how a particular object is developing in a number of projects, you do not need to analyze that object in each project individually. A more efficient method is to use project summarizations. This enables you to view the data you want in a single report, rather than having to access individual reports for each project.

For more information on summarization, see: [Project Summarization \[Page 105\]](#).

## Technical Project Reports

### Purpose

The Information System for structures mainly covers aspects of technical project monitoring and control.

### Features

- You can select all or specific objects in a project, such as WBS elements, networks, activities, PS texts, or material components, and view their current status as well as their position in the project hierarchy.
- From the values you entered as selection criteria on the initial screen, the system creates a structure list. You can use this list to call up further overviews, display graphics, such as SAP Business Graphics, or transfer data to Microsoft Project®, or Microsoft Excel®.
- The Information System for structures allows you to evaluate not only original data but also data from simulation and project versions and archived projects.
- In the Information System for structures you can create and compare project versions. For more information, read [Project Versions in the Information System \[Ext.\]](#).

---

**Important Technical Note Regarding the Use of Overviews**

## Important Technical Note Regarding the Use of Overviews

For technical reasons, overviews in the Project Information System are supported on two levels.

- In release 4.6C via the Easy Access Menu



Please note that these overviews are no longer maintained. For more information read the note mentioned below.

- In release 4.5B via transaction codes

Note 326591 describes these reasons in detail.

### **In release 4.6C via the Easy Access Menu**

You can find more information in the following documentation:

- [Easy Access: Overviews in the Information System \[Page 45\]](#)
- [Easy Access: Structure Overview \[Page 48\]](#)
- [Easy Access: Working with Overviews \[Page 47\]](#)
- [Easy Access: Calling up Individual Overviews Directly \[Page 50\]](#)

The documentation [Old Information System Functions \[Page 34\]](#) describes functions you are probably already familiar with, however these functions are no longer available in Information System 4.6C

### **In release 4.5B via transaction codes**

You can find more information in the following documentation:

- [45B: Overviews in the Information System \[Page 39\]](#)
- [45B: Structure Overview \[Page 42\]](#)
- [45B: Working with Overviews \[Page 41\]](#)
- [45B: Calling Up Individual Overviews Directly \[Page 44\]](#)

## 45B: Overviews in the Information System

### Use

The system uses the values you enter in the selection screen to create a structure overview. You can branch from there to individual overviews and detail screens. The following graphic shows you how to navigate among the individual overviews.

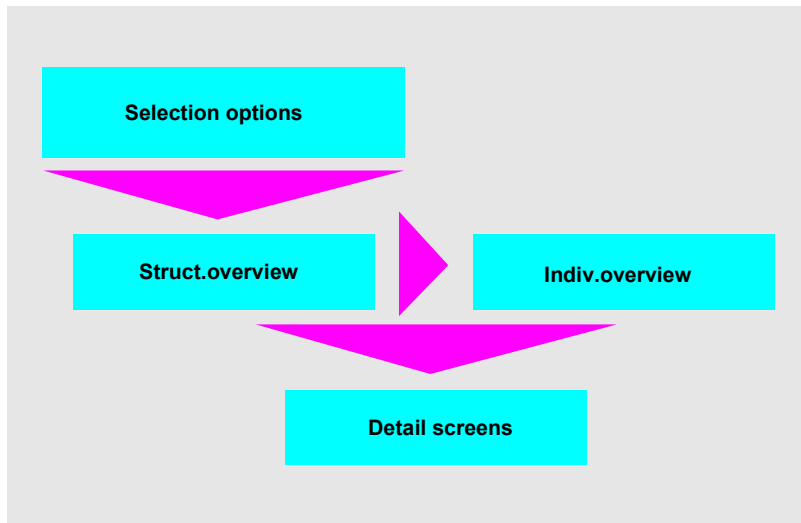

### Features

In addition to the structure overview, the system includes the following:

#### Individual Overviews

- Project definitions
- WBS elements
- Networks
- Activities
- Orders
- Sales documents
- Sales document items
- Relationships
- Milestones
- Production resources/tools (PRT)
- Confirmations

## 45B: Overviews in the Information System

- Material components
- Planned orders

### See also:

- [45B: Structure Overview \[Page 42\]](#)
- [45B: Calling Up Individual Overviews Directly \[Page 44\]](#)
- [45B: Working with Overviews \[Page 41\]](#)

## 45B: Working with Overviews

### Variable Overviews

In the structure overview, you can stipulate and display different data for each object. You define an overview variant in Customizing for the information system.

1. Choose *Goto* → *Structure overview* → *Variable overview*.

A dialog box appears.

2. Select an overview variant and choose *Continue*.

The overview is displayed.

### Individual Overviews

To call up individual overviews from the structure overview, proceed as follows:

1. Select the relevant project objects in the object list.
2. Choose *Goto* → *Individual overview*.

The individual overview is displayed.

3. Return to the structure overview.

You can also call up the individual overviews using transaction codes. See [45B: Calling Up Individual Overviews Directly \[Page 44\]](#) for details.

### Detail Screens

You can call up detail screens for all project objects in the structure or individual overviews. The detail screens show general information on the project object, for example, activity or WBS element data.

1. Select the object in the *Project Structure* column
2. Place the cursor on the object and press the right mouse key. Choose *Detail Screen* from the resulting list of options.

The details appear in a popup.

3. Return to the overview.

---

**45B: Structure Overview**

## 45B: Structure Overview

### Definition

The structure overview is a flexible overview report, enabling you to survey the structure of your project according to various criteria which you can choose from those on offer.

### Use

If you are not using the Easy Access menu, you can only access the structure overview using the transaction code CNS41.

To access the structure overview, proceed as follows:

1. Enter transaction code CNS41 in the transaction code field and press *Enter*.  
A selection screen appears.
2. Enter the project and/or other objects whose structure you want to view.
3. Choose *Continue*.

The system displays the basic structure overview for the object(s) you selected.

### Structure

The overview first displays the basic structure of the project. To expand the structure to show all the objects on each level, click the right pointing arrow next to the object in the level whose objects you want to view.

The icon menu at the top of the display area contains all the most commonly used functions, such as *Sort in descending/ascending order*, *Save*, *Print*, and *Refresh*. However, there is a large range of additional functions you can add to this toolbar in order to tailor the structure overview to your specific requirements.

Proceed as follows:

1. Click the *Choose functions* icon.  
A dialog box appears, divided into two halves. On the right-hand side, the system shows the functions already active. The left-hand side shows the functions that are not active. Right-pointing arrows indicate functions that can be broken down further. Click the arrow to expand the display. A red square next to each function indicates that the function is not active.
2. In the left-hand side of the dialog box, click the function you want to use and drag it to the right-hand side.  
The function is then sorted into the list on the right-hand side of the dialog box. A green circle next to the function indicates that it is now active in your overview.
3. When you have chosen all the functions you want to add to your display, press *Copy*.  
The relevant icons now appear to the right of the vertical slash in the icon menu. This means the functions are available for use.

### Integration

From the structure overview, you can do the following:

## 45B: Structure Overview

- Access the period drilldown. Choose *Evaluate* → *Period Drilldown*.
- Export project data to external applications. For example, to export data to MS Access, choose *Evaluate* → *Export* → *MS Access*.
- Access individual overviews for objects such as project definitions and WBS elements.
- Access graphical displays for project objects.
- Create a Microsoft Project (MPP) file for the project definition or a WBS element. To do this:
  - Select the project definition or a WBS element.
  - Choose *Generate MPP File*.
  - Specify a menu path.

The system then generates an MPP file for the project definition/WBS element. Remember to save it.

The structure overview now shows that an MPP file exists for the project definition/WBS element.



You can only use this function if you have installed OpenPS in full.

- Display original documents for objects appearing in the overview. To do this:
  - Select the object whose original document(s) you want to display.
  - Either click the right mouse button and choose *Display original document* or choose the *Display original document* pushbutton.

If there is only one original document, the system displays it. If there is more than one, a list appears, inviting you to choose which type of document, such as Microsoft PowerPoint documents, you want to display. You can choose to display all of them.
  - When you have made your selection, the relevant documents are displayed. You can process them here.

**45B: Calling Up Individual Overviews Directly****45B: Calling Up Individual Overviews Directly****Use**

You can also call up the individual overviews directly, without accessing the structure overview first.

To do this, enter the transaction code shown in the table below for the overview you want to see:

**Individual Overview Transactions**

<b>Overview</b>	<b>Transaction</b>
Project definitions	CNS42
WBS elements	CNS43
Planned orders	CNS44
Orders	CNS45
Networks	CNS46
Activities	CNS47
Confirmations	CNS48
Relationships	CNS49
Capacity requirements	CNS50
Production resources/tools (PRT)	CNS51
Components	CNS52
Milestones	CNS53
Project/network change documents	CNS60
Progress analysis	CNSE5

## Easy Access: Overviews in the Information System

### Use

The system uses the values you enter in the selection screen to create a structure overview. You can branch from there to individual overviews and detail screens. The following graphic shows you how to navigate among the individual overviews.

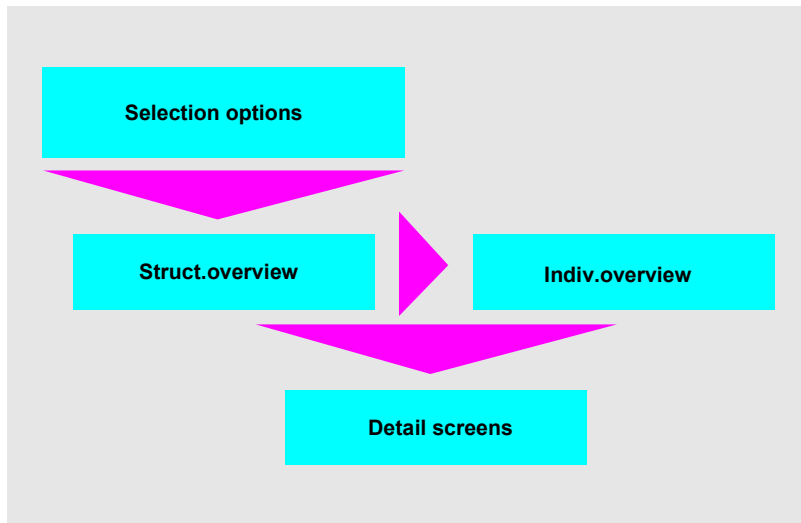

### Features

In addition to the structure overview, the system includes the following:

#### Individual Overviews

- Project definitions
- WBS elements
- Networks
- Activities
- Orders
- Sales documents
- Sales document items
- Relationships
- Milestones
- Production resources/tools (PRT)
- Capacity requirements

**Easy Access: Overviews in the Information System**

- Confirmations
- Material components
- Planned orders

**Where.Used Lists**

- Standard networks for work centers
- PRT in standard networks
- PRT in networks

**Reports on Change Documents**

- For project/network
- For standard WBS
- For standard network

## Easy Access: Working with Overviews

### Variable Overviews

In the structure overview, you can stipulate and display different data for each object. You define an overview variant in Customizing for the information system.

3. Choose *Goto* → *Structure overview* → *Variable overview*.

A dialog box appears.

4. Select an overview variant and choose *Continue*.

The overview is displayed.

### Individual Overviews

To call up individual overviews from the structure overview, proceed as follows:

4. Select the relevant project objects in the object list.
5. Choose *Individual overview*.

The individual overview is displayed.

6. Return to the structure overview.

You can also call up the individual overviews directly from the Easy Access menu. See [Calling Up Individual Overviews Directly \[Page 50\]](#).

### Detail Screens

You can call up detail screens for all project objects in the structure or individual overviews. The detail screens show general information on the project object, for example, activity or WBS element data.

4. Select the object in the *Project Structure* column
5. Place the cursor on the object and press the right mouse key. Choose *Detail Screen* from the resulting list of options.

The details appear in a popup.

6. Return to the overview.

## Easy Access: Structure Overview

### Definition

The structure overview is a flexible overview report, enabling you to survey the structure of your project according to various criteria which you can choose from those on offer.

### Use

You use the structure overview to survey the structure of your project according to various criteria. It also acts as a starting point for accessing more detailed information in the form of individual overviews.

To access the structure overview, proceed as follows:

4. In the SAP Easy Access menu, choose *Logistics/Accounting* → *Project System* → *Information System* → *Structures* → *Structure Overview*.

A selection screen appears.

5. Enter the project and/or other objects whose structure you want to view.
6. Choose *Continue*.

The system displays the basic structure overview for the object(s) you selected.

### Structure

The overview first displays the basic structure of the project. To expand the structure to show all the objects on each level, click the right pointing arrow next to the object in the level whose objects you want to view.

The icon menu at the top of the display area contains all the most commonly used functions, such as *Sort in descending/ascending order*, *Save*, *Print*, and *Refresh*. However, there is a large range of additional functions you can add to this toolbar in order to tailor the structure overview to your specific requirements.

Proceed as follows:

4. Click the *Choose functions* icon.

A dialog box appears, divided into two halves. On the right-hand side, the system shows the functions already active. The left-hand side shows the functions that are not active. Right-pointing arrows indicate functions that can be broken down further. Click the arrow to expand the display. A red square next to each function indicates that the function is not active.

5. In the left-hand side of the dialog box, click the function you want to use and drag it to the right-hand side.

The function is then sorted into the list on the right-hand side of the dialog box. A green circle next to the function indicates that it is now active in your overview.

6. When you have chosen all the functions you want to add to your display, press *Copy*.

The relevant icons now appear to the right of the vertical slash in the icon menu. This means the functions are available for use.

## Integration

From the structure overview, you can do the following:

- Access the period drilldown. Choose *Evaluate* → *Period Drilldown*.
- Export project data to external applications. For example, to export data to MS Access, choose *Evaluate* → *Export* → *MS Access*.
- Access individual overviews for objects such as project definitions and WBS elements.
- Access graphical displays for project objects.
- Create a Microsoft Project (MPP) file for the project definition or a WBS element. To do this:
  - Select the project definition or a WBS element.
  - Choose *Generate MPP File*.
  - Specify a menu path.

The system then generates an MPP file for the project definition/WBS element. Remember to save it.

The structure overview now shows that an MPP file exists for the project definition/WBS element.



You can only use this function if you have installed OpenPS in full.

- Display original documents for objects appearing in the overview. To do this:
  - Select the object whose original document(s) you want to display.
  - Either click the right mouse button and choose *Display original document* or choose the *Display original document* pushbutton.

If there is only one original document, the system displays it. If there is more than one, a list appears, inviting you to choose which type of document, such as Microsoft PowerPoint documents, you want to display. You can choose to display all of them.
  - When you have made your selection, the relevant documents are displayed. You can process them here.

---

**Easy Access: Calling Up Individual Overviews Directly**

## Easy Access: Calling Up Individual Overviews Directly

You can also call up the individual overviews directly from the *Project Information System* menu. To do this, choose *Structures* → *Individual Overviews*, then choose the overview you want from the following:

- Project definitions
- WBS elements
- Networks
- Activities
- Orders
- Sales documents
- Sales document items
- Relationships
- Milestones
- Production Resources/Tools (PRT)

Some other individual overviews appear in other menu paths.

- Capacity requirements: in the information system part of the Project System menu, choose *Resources* → *Capacity Requirements*.
- Confirmations: in the information system part of the Project System menu, choose *Progress* → *Confirmations*.
- Material components: in the information system part of the Project System menu, choose *Material* → *Material Components*.
- Planned orders: in the information system part of the Project System menu, choose *Material* → *Planned Orders*.

## Statistics

### Use

You can use statistics to obtain an overview of various key figures in your project. You can choose statistics for: *All selected objects*, *All filtered objects* or *All displayed objects*.

### Features

The statistical display shows the number of WBS elements, activities, milestones, sales document items, and other objects in your project. For the WBS elements and network activities you can also see how many:

- Are critical
- Started too early/late
- Finished too late
- Have a start date that lies in the past

In addition to statistics on project progress, you can obtain statistics on the size of the project before you access it. For more information, refer to *Checking the Selection Scope* in [Data Selection for the Overview \[Page 13\]](#).

### Activities

You obtain a statistical overview of your project by choosing *Goto* → *Statistics* in the initial screen.

## Graphics in the Information System

### Use

In the information system, graphics are generally grouped into two categories: [PS-Graphics \[Page 53\]](#) and [SAP Business Graphic \[Page 58\]](#).

You can call up the following graphics:

#### PS Graphics

- Structure graphic
- Work breakdown structure graphic
- Network structure graphic
- Gantt chart

#### Business Graphics

- Portfolio graphic
- Period drilldown
- Histogram
- Totals curve
- Correlation
- ABC analysis
- Classification
- Segmenting

## PS Graphics

### Use

The sections which follow describe the Project System graphics which have characteristics in common:

[Structure Graphic \[Page 54\]](#)

[WBS Graphic \[Page 55\]](#)

[Network Structure Graphic \[Page 56\]](#)

[Gantt Chart \[Page 57\]](#)

[Overview of Graphics in the Information System \[Page 52\]](#)

### Graphic Profiles

The graphic profiles stored in customizing determine how the individual PS graphics are displayed. You can assign a graphic profile to each project object, such as networks or the WBS. If you then call up the network structure graphic, for example, the system automatically calls on the graphic profile you assigned to the network. If more than one profile has been assigned to the network, the system uses the one assigned first.

### General Information

- Only those project objects which appear in the overview will be displayed in the graphic. This means that, if you have used filters, those objects which were filtered out will not be shown.
- For the objects to be displayed in the graphic, you must select the required objects in the overview before accessing the graphic.
- You can branch from the graphic to detailed screens for specific objects, such as network activities.
- Use the *Search* icon to search for objects.
- You can hide/show a legend.
- You can have the graphic output on a printer or plotter.
- You can send copies of the graphic to other users.

---

**Structure Graphic**

## Structure Graphic

### Use

In some cases, only a graphical overview can offer a clear enough view of your project. You can use the structure graphic to represent the project elements in an evaluation in graphical form. For example, you can display a network, its activities, and activity elements as a hierarchy.

### Features

You can:

- Hide/show a title
- Perform general hierarchy functions such as hide/show subtrees, expand/collapse hierarchies, and so on
- Arrange objects vertically or horizontally

## Work Breakdown Structure Graphic

### Use

In the work breakdown structure graphic you can hide/show the hierarchy for selected WBS elements and activities.

### Features

You can:

- Change the display of the WBS elements and activities
- Change the set of dates (basic, forecast, or actual) for the activities either while in the graphic or before you call it up by choosing *Settings* → *Graphic* → *Project/network structure*
- Arrange objects vertically or horizontally
- Hide/show and change the title
- Perform general hierarchy functions such as hide/show subtrees or expand/collapse hierarchies

---

**Network Structure Graphic**

## Network Structure Graphic

### Use

In the network structure graphic, you can display one or more networks or standard networks.

### Features

You can:

- Change the display of the activities and relationships
- Group activities by network or by network element
- Perform loop analysis and eliminate loops This is **only** possible in the network structure graphic.
- Change the set of dates (basic, forecast, or actual) for the activities either while in the graphic by choosing *Settings Set of dates (activities)* or or before you call it up by choosing *Graphic → Graphic settings → Project/network structure*
- Hide/show and change the title
- Use general hide/show functions to summarize activities into just one node

## Gantt Chart

### Use

In the Gantt chart you can view the project schedule as well as obtain an overview of the earliest and latest start and finish dates for:

- WBS elements
- Networks
- Network activities
- Planned orders
- Production orders
- Milestones
- Capacity requirements

### Features

You can change the:

- Display of activities and relationships.
- Dates of project objects simply by double clicking the time bar in the graphic area.

## SAP Business Graphics

### Use

The SAP business graphics are available in most of the R/3 information systems. They have many characteristics in common and include:

- Portfolio graphic
- Period drilldown graphic
- Histogram
- Totals curve
- Correlation
- ABC analysis
- Classification
- Segmenting

### Features

- There is no graphic profile for SAP Business Graphics
- Only those project objects which appear in the overview will be displayed in the graphic. This means that, if you have used filters, those objects which were filtered out will not be shown.
- You must first position the cursor on the relevant column in the overview, before you call up the graphic, in order to have the values displayed in the graphic. However, you do **not** have to select project objects

#### See also:

For detailed information on the SAP Business Graphics, refer to [LO Standard Analysis \[Ext.\]](#).

## Portfolio Graphic

### Use

In the portfolio graphic you can compare trends in your project(s) based on summarized planned and actual costs or durations, for example. You can compare up to 15 numerical values in the portfolio graphic.

When you call up the portfolio graphic for the first time, or when you select fields by choosing *Graphic* → *Graphic Settings* → *Portfolio Fields*, the system copies the fields with numerical values from all of the fields on the overview.

### Features

- There is no graphic profile for SAP Business Graphics.
- You can analyze different trends by simply changing the position of values in the graphic, for example, from the X-axis to the Y-axis.

---

**Period Breakdown**

## Period Breakdown

The breakdown by period can be displayed both as a table and as a graphic. In both cases, the values of the project objects in the structure overview are displayed over time. In the Project System, the period breakdown graphic is especially useful for progress analysis.

### Displaying the Graphic for Progress Analysis

1. Make sure that the profile **SAPPS\_EV0001** for progress analysis has been set in Customizing.



The profile SAPPS\_EV0001 is for displaying earned values in the information system. This is **not** a profile for the period drilldown graphic.

2. Choose *Information System* → *Progress* → *Progress Analysis* → *Structure Overview*.
3. Choose *Graphic* → *Period Breakdown*.
4. The period breakdown graphic is displayed.

## Confirmations

You can enter and cancel confirmations from the project information system.

**See also:**

[Confirmations \[Ext.\]](#)

[Entering Confirmations in the Information System \[Page 62\]](#)

[Creating a Pool of Confirmations in the Information System \[Page 63\]](#)

[Creating a Workflow for Confirmations \[Page 65\]](#)

---

**Entering Confirmations in the Information System**

## Entering Confirmations in the Information System

Proceed as follows:

1. Select the activities and activity elements you want to confirm.
2. Press the right mouse button and choose *Individual Confirmation*.  
The system branches to confirmation processing.
3. Enter the data for the confirmation and save.

Alternatively, you can use *Choose Functions* facility to add the confirmation functions to the icon toolbar. Then use the functions to make the confirmations.

## Creating a Pool of Confirmations in the Information System

1. Select the activities and activity elements for which you want to create a confirmation pool.
2. Press the right mouse button and choose *Create confirmation pool*.  
A dialog box appears.
3. Enter a name and a description for the pool of confirmations in the dialog box and save.  
The pool of confirmations is saved.

---

**Deleting a Pool of Confirmations in the Information System**

## Deleting a Pool of Confirmations in the Information System

Proceed as follows:

1. Select the activities and activity elements for which you want to delete a confirmation pool.
2. Press the right mouse button and choose *Delete Confirmation Pool*.

A dialog box is displayed.

3. Enter the name or the pool of confirmations in the dialog box and choose *CONTINUE*.

The system asks you if you want to delete the pool.

4. Choose *Yes*.

The pool of confirmations is deleted.

Alternatively, you can use *Choose Functions* facility to add the confirmation functions to the icon toolbar. Then use the icon for deleting pools of confirmations.

## Creating a Workflow for Confirmations

You can create a workflow for confirmations. To do this you use standard task 7944 from workflow. You can send the pool of confirmations to different addresses, for example, a user or a work center.



So that you can send the workflow to the appropriate person or area, the standard task must be linked with the corresponding user.

### Procedure

1. Select the activities and activity elements for which you want to create a confirmation pool.
2. Press the right mouse button and choose *Confirmation workflow*.  
A dialog box appears.
3. Enter a name and a description for the pool of confirmations in the dialog box. Select the address who is to receive the workflow, and enter the object ID, for example, the user ID.
4. Choose *Continue*.

The pool of confirmations is created and sent.



You cannot make changes to existing confirmations from the information system.

Alternatively, you can use *Choose Functions* facility to add the confirmation functions to the icon toolbar. Then use the "Create Pool of Confirmations" function.

## Accessing Capacity Evaluations

### Prerequisite

You define the profiles to do this in Customizing for the Project System.

For more information on capacity evaluations, refer to [Capacity Planning \[Ext.\]](#).

### Procedure

1. In the structure overview, select the project objects for which you want to have capacity evaluations.
2. Choose *Goto* → *Information system* → *Capacities*.  
The screen *Capacity Planning: Selection List* appears:
3. Enter additional data or overwrite the defaults and confirm.  
The standard overview is displayed.
4. You can call up other individual overviews from the *Goto* menu.
5. You return to the structure overview by pressing F12.

## Accessing Cost Reports from the Structure Overview

### Prerequisite

You define the profiles for accessing these evaluations in the Project System IMG.

### Procedure

1. Choose *Goto* → *Information System* → *Cost Report* → *Choose Cost Report*.  
A dialog box is displayed.
2. Choose a report and confirm.
3. Choose *Goto* → *Information System* → *Cost Report* → *Execute Cost Report*.  
The initial screen for report selection is displayed.
4. Enter a plan version and choose *Proceed*.  
The cost report is displayed.

---

**Branching to Other Information Systems**

## Branching to Other Information Systems

You can call up the following information systems by choosing *Goto* → *Information system* :

- Cost report
- Capacities
- Reservations
- Purchase requisitions
- Purchase orders
- Outline purchase agreements
- General purchasing documents

## Commercial Project Reports

### Purpose

Various evaluations are available for you to use when analyzing and monitoring commercial data; you can, for example, vary the degree of detail. This means you can run recurring standard reports and create reports for more unusual information needs and tasks. You can analyze all data online as soon as it is entered and trace its origin back to the document level. You can analyze data in summarizations by, say, responsibility area.



The commercial project reports display only those objects in which commercial data, such as costs, was posted.

### Features

You can access different evaluations to meet your various information needs.

- Access the [cost/revenue/payment hierarchy reports \[Page 72\]](#) to obtain an overview of the whole value flow in the project. The hierarchy reports are based on drilldown.
- For detailed information at cost element level about costs and revenues, look at the [cost element reports \[Page 89\]](#). You can use the cost element reports to summarize line items, in the form of totals records, according to your own criteria.
- You can use the [line item reports \[Page 98\]](#) to evaluate individual actual, plan, commitment, and budget values.
- With the [CO document display \[Page 104\]](#), you can view documents relating to actual cost accounting postings and, subject to certain conditions, plan postings.  
Unlike the line item reports, this display always shows the completed document, regardless of which cost accounting objects are affected.
- With the [project summarization \[Page 118\]](#), you can evaluate transaction data within a controlling area according to different views and summarization characteristics. You can access this data in the information system, thereby improving information system performance. Summarization reports are available for hierarchy reports and cost element reports.

The table provides guidance on how to choose the report you need:

Information Required	Report
Internal business volume in settlement	Hierarchy report
Order plan values as commitments	Hierarchy report
Budgeting and cost planning	Hierarchy report
Payment data	Hierarchy report
Incoming orders	Hierarchy report
Open orders	Hierarchy report

**Commercial Project Reports**

Costs to complete (CTC)	Hierarchy report
Detailed actual, plan, and commitment values by object	Cost element report
Debits and credits by object	Cost element report
Plan data from the network costing, by cost element	Cost element report
Quantities	Cost element report
Statistical key figures	Cost element report
Credit from settlement	Cost element report

Regardless of which report you access first, you can navigate between the various reports using the report-report interface.

However, as projects vary widely in what they do and how they do it, you can create your own reports; use the drilldown to create hierarchy reports and Report Painter to create cost element reports. Alternatively, you can adapt the layout and content of existing reports to meet your own requirements.

The system first translates the cost report values into controlling area currency and displays them accordingly, regardless of the currency in which the values were entered. If you want to evaluate the report in a different currency or in more than one currency, you can define appropriate reports of your own. The system we deliver contains a sample hierarchy report and a sample cost element report which you can use as templates.

For more information, read [Currencies in the Information System \[Page 33\]](#).

The hierarchy reports are based on drilldown. For more information, read the [CA General Drilldown \[Ext.\]](#) documentation.

Cost element reports are Report Painter or Report Writer reports. For more information, read [Report Painter Reports \[Ext.\]](#).

The line item reports are based on the ABAP List Viewer. For more information, read the [ABAP List Viewer \[Ext.\]](#) documentation.

For more information on the report-report interface, read [Report-Report Interface \[Ext.\]](#).

## Reports on Project Materials

### Use

Most projects use materials, either valuated or non-valuated. The project information system includes a number of reports you can use to obtain information on, for example, what materials have been used, where, and when.

### Features

The project information system includes the following reports on materials:

- Material Components
- Stock/Requirements
- Missing Parts
- Pegged Requirements
- Order Report
- Reservations
- Planned Orders
- Outline Agreements
- Valuated Project Stock
- Purchase Requisitions/Purchase Orders
  - For Project
  - For Account Assignment

To run them, go to the Project System part of the Easy Access menu and choose *Information System* → *Material*. Then select the report you want.

---

**Hierarchy Reports: Costs, Revenues, and Payments**

## Hierarchy Reports: Costs, Revenues, and Payments

### Use

With this function, the system represents the value flow of commercial data in single projects, partial projects, or across several projects, from hierarchical points of view. The evaluation is based on all the data in the project information database (RPSCO).

The database contains all project-related cost, revenue, and payment data, summarized by value category. Value categories are groupings of cost elements and commitment items.

The following are among the cost/revenue/payment values available in the reports:

- Actual
- Commitment
- Plan
- Budget
- Sales order
- Results analysis
- Internal business volume
- Transfer prices
- Orders for projects
- Overall plan

The values in the hierarchy reports are compiled per attributes and key figures. The data is made available for evaluation, and the hierarchy is set up, in line with the attributes and key figures defined. This way, you can use attributes and key figures to reproduce special features of your hierarchy - for example, to take account of the elimination of internal business volume.

Various [standard hierarchy reports \[Page 87\]](#) have been predefined:

For details on the hierarchy setup and its effect on the values shown in the reports, read [Hierarchy Setup and its Effect on Displayed Values \[Page 86\]](#).

You can create your own reports to complement the standard reports.

### Prerequisites

Before using the hierarchy reports, you must do the following in the Project System IMG:

- Define value categories

You do this before making any postings. The system uses the value categories when evaluating the data. For the system to be able to evaluate data correctly in the hierarchy reports, you must assign the cost elements and commitment items to the value categories. There is a checking program you can use to verify the assignment.
- Transport standard reports and reports you have defined yourself from client 000.
- You must reconstruct the project information database when you first access the report and when you subsequently change any of the value categories.

## Hierarchy Reports: Costs, Revenues, and Payments

## Features

- You can use hierarchy reports to evaluate one project or several. The system selects the data for the following objects:

- Work breakdown structure (WBS)
- Network
- Activity
- Order
- Component (valuated stock only)
- Value categories



Evaluation is within a controlling area. The controlling area determines which currency and fiscal year variant are used.

- You can navigate through the data in a report according to various attributes and indicators. You do not need to select the data from the database again. You can evaluate the data per the following attributes:
  - Period or year, cumulative
  - Value categories
  - Objects
  - Currencies
  - Results analysis categories
  - Business transactions
- You can use the report/report interface to call up more reports. You can branch to the following types of report:
  - Further hierarchy reports
  - Cost element reports
  - Line item reports



You use the report/report interface parameters to stipulate the reports to which you can branch. If you have defined new reports, you must maintain the parameters to accommodate these, then update the list in the report/report interface. You maintain the report/report interface parameters using a copy function in the Project System IMG. Choose *Information System* → *Costs/Revenues Information System* → *Hierarchy Report* → *Report Assignment* → *Copy Report-Report Interface*.

Settings within the report:

- You can evaluate data per various sort criteria and views.

You define the view in the database profile. To change the view when in the report evaluation, choose *Edit* → *Hierarchy* → *Select*.

## Hierarchy Reports: Costs, Revenues, and Payments

- You can evaluate simulations. You select the hierarchy in line with the simulation version.

### Activities

The essentials for creating a hierarchy report are as follows:

- Create a form  
You use a form to stipulate the contents and structure of the detail list in a report. Among other things, you define the value types to be displayed in a report - for example: the plan, actual, and/or budget values.
- Create the report  
When you create the report, you define the drilldown list for the report. In the process, you stipulate the attributes used to evaluate the data in a report.



At this time, you must use forms to create reports in the Project System.

The text which follows contains an example of defining a report, in which you can compare plan, actual, commitment, and assigned values.

For more information on how to use drilldown to define reports, refer to the [general drilldown documentation \[Ext.\]](#).

## Example: Creating Forms

### Starting Point

In our example, we will define a form for a report where we can compare plan, actual, commitment, and assigned values.



Before starting work, you might find it useful to look at one of the standard forms, such as 12KST1C, which we supply with the system.

### Defining the Form

1. Go to the Project System part of the Easy Access menu and choose *Information System* → *Tools* → *Hierarchy reports* → *Form* → *Create*.
2. Specify the controlling area for the form.

The *Specify Report Type* dialog box is displayed. You can choose between creating a project report or a summarization report for projects.
3. Choose *Project report*.

The screen *Report Painter: Create Form* appears. You can also use templates to create forms. However, we will not do this in this example.
4. Enter a name and description for your form.
5. Choose *Two axes (matrix)*, then *Create*.

The system displays a form with four rows and four columns. Every definable field in the screen is called an “element”. Every row, column, and cell in the form is an element.

### Defining Rows

In the example, we will first define the time axis of the project analysis in the report rows.

1. Position the cursor on Row 1 in the blank form and choose *Edit* → *Element* → *Change/display element*.

The *Select Element Type* dialog box appears.
2. Choose *Characteristics*.

The next dialog box offers all the characteristics which can be entered in the rows. You may choose one or more characteristics.
3. Choose *Fiscal year*, then press the single arrow pointing left.

*Fiscal year* now appears in the *Selected* table.
4. Define the value(s) for the characteristic.

These can be either fixed values or variables. In our example, we will define a report row for values from previous years.

**Example: Creating Forms**

For detailed information on defining variables, read the [general drilldown \[Ext.\]](#) documentation.

5. Check the  *Flag for entering variables*.

The *Variable selection* dialog box appears, showing the global variables available.

6. Choose the global variable **0FY** (current fiscal year).

7. In the *Operator* field, enter a minus sign (-), then enter 1 in the *Offset* field.

This combination of the global variable, operator, and offset means you have now stipulated the fiscal year prior to this one.

8. Confirm your entries. Then choose  *Change short, middle, and long texts*.

9. In our example, we will enter *Prev.year* in the first input field and choose *Copy short text*.

10. Choose *Continue*.

The system copies the text into row 1. You have defined the first row of your form.



From the second element, specify in the dialog box whether the element is defined using characteristics and their values, or using a formula.

11. In our example, we will now make the following entries:

- Row 2 for the current fiscal year

In the *Characteristic values* dialog box, enter the variable **0FY** in the first input field.

- Row 3 for future fiscal years

In the *Characteristic values* dialog box, enter the variable **0FY+1** in the first input field and 2999 in the second.

13. We will use row 4 to calculate the total for all the fiscal years, by entering the appropriate formula. To do this, choose *Formula* in the dialog box *Choose Element Type*.

This accesses the formula editor where you can enter a formula based on the elements maintained so far (in the example, rows).

14. This “total” will comprise the values in rows 1, 2, and 3.

To this end, click the ID for row 1. This then appears in the empty box in the top half of the popup. Then click the relevant operator (in our example, the plus sign) which likewise appears box. Then click on the ID for row 2 and repeat the process until you have entered all three rows. The system will ask you to enter texts for the formula.

This completes row definition for the form in the example.

**Defining Columns**

1. Choose *Edit* → *Element* → *Change/display element*.

The *Select Element Type* dialog box appears.

2. In the dialog box *Select Element Type*, choose *Predefined element*.

## Example: Creating Forms

The *Choose Form* dialog box appears, where you can choose from all the predefined elements available.

Elements are defined for the Project System in the following groups:

- *Plan values*
- *Budget values*
- *Commitment values*
- *Cost/revenues*
- *Funds*



These predefined elements are one-coordinate forms with key figures, in which, for example in the case of plan values, elements for different types of planning (cost/revenue/payment planning) are stored.

By creating one-coordinate forms, you can set up predefined columns yourself.

3. Choose *Plan values*.

The next dialog box offers all the elements from the *Plan values* index which can be entered in the columns.

4. For our example, we will choose *Project cost plan*.

The *Project Cost Plan Element: Choose Characteristics* dialog box.

Do not change the settings.

5. Choose *Continue*.

The *Maintain Texts* dialog box, containing texts in line with your selection, appears. You can overwrite the texts.

6. Choose *Continue*.

If the text corresponds to the prescribed column width, the system copies it to the column. You have now defined Column 1 of your form.

7. Use the same procedure to define:

- Column 2: actual costs (*Costs/revenues*)
- Column 3: total cost commitment (*Commitment values*)

In column 4, define the assigned values (actual and commitment values) as the total.

8. Choose *Column 4*.

The *Select Element Type* dialog box appears.

9. Choose *Formula*.

10. In the formula editor, format a total from the columns for actual costs and cost commitments.

Choose *Assigned* as the column name. This completes the form.

11. Check the form and save it.

---

Example: Creating Forms

## Changing Forms

When you change a form, remember that the form may already have been used in reports. Any change you make in a form affects all the reports where that form is used. Change the form if you want to change the layout for all the reports created with this form. Otherwise, create a new form, copying the details from the old form.

The following settings are not affected when you change a form:

- Report number format settings  
For further information on number formats, see [General Drilldown \[Ext.\]](#).
- Options chosen specifically for a report, and sorting of rows and columns for the drilldown list.

If you want to reset a report to the form setting, you can do this in the report change mode.

---

**Example: Creating Reports**

## Example: Creating Reports

### Prerequisites

A suitable form exists.

### Creating Hierarchy Reports

1. Go to the Project System part of the Easy Access menu and choose *Information System* → *Tools* → *Hierarchy Reports* → *Report* → *Create*.

The *Specify Report Type* dialog box is displayed. You can choose between creating a project report or a summarization report for projects.

2. Choose *Project report*.

This brings you to the *Create Project Report: Initial Screen*. You can also use templates to create reports. However, we will not do this in this example.

3. Enter a name and short description for your report.
4. In the *With form* field, enter the form you have defined.
5. Choose *Create*.

This brings you to a screen with four tab pages. Choose the one marked *Variables*. This brings up the *Create Project Report: Enter Variables* screen. As you have defined a plan column in your form and the plan values are kept in versions defined as variables, the screen includes the field *Plan version*.

6. Choose standard plan version *0 Plan/actual version* and the parameter *Enter at execution*.

When you choose this parameter, the field *Plan version* is displayed in the selection screen when you execute the report, and the variables can be changed.

7. Choose *Characteristics*.

This brings you to the *Create Project Report: Specify Characteristic Values* screen where you can select the characteristics you need for your evaluation. These are drilldown characteristics, which you can use to navigate in your report.

8. Choose the following:

- *Value categories*
- *Business transaction*
- *Period/year*

Press the single left-pointing arrow to have the system copy the values into the *Selection characteristics* table.

The characteristic *Object* is set as standard default, and occupies first position in characteristic sorting.

9. Choose *Sort free chars* .

The *Sort Characteristics* dialog box appears.

10. Confirm the sequence offered by the system.

**Example: Creating Reports**

11. Choose *Extras* → *Initial list* and then stipulate whether you want to see the detail list or the drilldown list first after you run the report.
  - If you choose the detail list, the detail list, as defined by you in the form, appears first. The system shows the values for the whole selection - for example, a project.
  - If you choose the drilldown list, the drilldown list, as defined by you, appears first  
As the *Object* usually occupies the first position in the characteristic sequence, the project hierarchy is displayed, showing the comparison of values, as defined by you in the form, after the report has been run. The values are then shown for each individual object in the project (WBS element, network, network activity, order).  
You can use cursor positioning on report lines to access detailed information about the object selected.
12. Choose *Drilldown list*.
13. Choose the *OutputType* tab to specify how the report output should be presented - for example, as a graphic.
14. Save your report.

**Result**

You have created a hierarchy report.

## Assigning Reports

# Assigning Reports

## Use

To be able to access additional project reports from a report, you must designate the relevant reports as receiver reports when you define them.

You do this by means of the report-report interface. For more information, see the information system section of the Project System IMG.

## Prerequisite

You assign the receiver reports when you create them, or when you later change them. To do the latter, you must access the change mode of a subobject from the report - for example, choose characteristics.

## Procedure

1. Choose *Extras* → *Report assignment* in the screen for creating/changing reports.  
The *Assign Reports* dialog box appears, showing a list of the existing hierarchy reports.
2. Choose *Insert row*.  
The system displays the dialog box *Enter Application Class*. The field contains the abbreviation *PS* for projects.
3. Choose *Continue*.  
The *Specify Report Type* dialog box is displayed.
4. Select the desired project type - example, project report.
5. Choose *Continue*.  
The system displays the dialog box *Add Drilldown*.
6. If you want to assign other report categories, such as Report Writer reports, choose *Other report type*. Select the desired category and confirm. The dialog box for entering reports appears.
7. Specify the name of the report you want to be able to access directly from your report. You can obtain a listing of all the available hierarchy reports.
8. Save your assignments.

## Result

When you run your report, you can branch to one of the assigned reports by choosing *Goto* → *Access report* → *Further reports*.

You can import the report-report interface entries from a source client.

## Creating Variants for Reports

### Use

You require variants for evaluations you use frequently and for reports you want to execute in the background.

### Procedure

1. To access variant maintenance, go to the Project System part of the Easy Access menu and choose *Information System* → *Tools* → *Hierarchy Reports* → *Background processing*.

The system asks you to specify a controlling area, then the *Specify Report Type* dialog box is displayed.

2. Choose whether you want to maintain a variant for project reports or summarization reports.

This takes you to the screen *Background Processing for Drilldown Reports*.

3. Choose  *Variant*.

The *ABAP: Variants - Initial Screen* appears.

4. Enter a name for the variant and choose  *Create*. The system may ask you to specify a database profile. Enter the one you require.

This takes you to the *Maintain Variant* screen, where you can maintain the selection criteria to appear when you access a project report.

5. Specify the parameters for report selection and executing reports in the background.
6. Save the attributes you have specified and enter a short text.

For more information on background processing, read [Background Processing \[Ext.\]](#) in the *BC-Computing Center Management System* documentation.

## Running Hierarchy Reports

### Prerequisites

You can access hierarchy reports from the Project Information System item in the SAP Easy Access menu by choosing *Controlling* → *Execute Report* → *Hierarchy Report*.

### Procedure

1. In the selection screen, enter the report program you want to run and choose *Continue*.
2. In the next screen, enter data as required.
3. When you access a report for the first time, you must choose a database profile. A database profile controls what objects (WBS elements, with hierarchy, networks, orders) are included in the selection. You can use *Change DB profile* to change the settings in the DB profile chosen.

For more information on the database profile, refer to [Working with the Information System \[Page 8\]](#).

4. Choose *Execute*.

### Result

The report shows the list which you defined as the basic list when creating the report. This may be the detail list or the drilldown list.

The lines in the drilldown list show the characteristic values for the characteristic which comes first in the sort sequence. The columns show the rows and columns of the detail list.

For more information on the drilldown list, refer to [Creating Reports \[Page 80\]](#).



In the hierarchy reports, the system evaluates the cost, revenue, and payment data, based on value categories. You can improve system performance when running such evaluations by combining cost/revenue elements and commitment items in value categories.

The following will familiarize you with the evaluation functions.

### Expanding the Hierarchy

The start list shows only the first two levels of the project hierarchy. To show the whole hierarchy, including assigned orders, networks, or network activities, choose *Navigate* → *Hierarchy* → *Expand all*.

### Navigation in the Hierarchy Report

Starting from the list you see in our example, you can navigate further in the report, calling up more detailed information. All the required functions are combined in the *Navigation* block in the list.

- Call up the detail list.
  - Choose *Display* to go to the detail list for an object in the list. Choose the desired object.

## Running Hierarchy Reports

The chosen object appears to the right of the navigation block. Use the symbols in front of the object to scroll through the object list.

Return to the basic list (or choose *Navigate* → *Basic list*) and then select the characteristic name *Object* which now appears in a different color.

- Drilldown functions

In the navigation block the system offers all the characteristics you specified when creating the report. The procedure for navigating between characteristics is the same as that described above. For example, if you click *Value category*, the symbols shown at the start of a line and the title of the first column are shown in a different color.

Select a line by clicking the colored symbol; this object is then broken down by value category. Use the green arrow in the navigation block to return to the initial list.

However, if you click the column header, the system switches the value category and object around, resulting in a different breakdown. In this case, the system shows the values per value category, cumulative across all objects. To return to the initial list, change the drilldown again, from *Value category* to *Object*.

Choose *Settings* → *Reverse* → *All settings* to return to exactly the list displayed when you started the report.

### Accessing Further Reports

Use the *Goto* menu to access further hierarchy, cost element, and line item reports. You can branch from the line item report to the corresponding document. If you have maintained your own assignments from reports, you can reach these by choosing *Call up report* → *Further reports* in the *Goto* menu.

### Further Functions in the Reports

For further information, see [General Drilldown \[Ext.\]](#).

---

**Hierarchy Structure and the Effects on Values Displayed**

## Hierarchy Structure and the Effects on Values Displayed

The text which follows describes some special features in the hierarchy structure for commercial reports and their effect on how values are displayed.

### Special Features in Assignment of Sales Order Items to WBS Elements

- A number of sales order items are assigned to the same WBS element.  
The WBS element is displayed in the sales order view, below the top sales order item. The revenues for the individual sales order items cannot be displayed separately.
- The sales order item is assigned to a WBS element which is not a billing element.  
The WBS element is displayed in the sales order view, below the sales order item. The billing element is not subordinate to either the sales order item or the WBS element in the hierarchy. As a result, the report does not show the revenues in the sales order item.

### Special Features in Settlement and Elimination of Internal Business Volume

Regardless of the view chosen, note the following re settlement to receivers which are in the project hierarchy:

- In settlement to the object directly superior in the hierarchy, the settlement is eliminated as internal business volume.
- If you settle to an object several levels higher in the hierarchy, the values do not appear in the intervening levels. For this reason, we recommend that you do not use this form of settlement.
- If you settle to an object lower down in the hierarchy, the values appear in the sender twice. Do not use this form of settlement.
- If you settle to a receiver not assigned to the sender in the hierarchy, the values are not totaled up by the sender, only by the receiver. The values do not appear in the WBS superior to the sender.
- Internal business volume is not eliminated in reports where the receiver is not selected.

## Standard Hierarchy Reports

We supply the following hierarchy reports as standard:

- Costs
  - Plan/actual/variance
  - Plan/actual/commitment/rem.plan/assigned
  - Plan1/plan2/actual/commitment
  - Actual in area/object/transaction currency
  - Plan/actual/down payment as expenditure
  - Commitment detail
  - Project version plan/actual comparison
  - Project plan version comparison
    - In the project version comparison reports, you can compare up to four versions with the original data. If you want to compare fewer than four versions, the system fills the other columns in the report with the selected version data. For technical reasons, the report cannot display empty columns.
  - Forecast
  - Project/Interest: Plan/Actual
  - Actual Costs for Each Month
  - Planned Costs for Each Month
  - Commitments for Each Month
  - Actual Costs: Aggregated
  - Actual/Planned Time Series
  - Planned/Actual/Variance for Each Project and Responsible Person
- Budget
  - Funds Overview
  - Budget/Actual/Variance
  - Budget/Plan/Commitment/Actual/Rem.Plan/Assigned
  - Budget/Distributed Budget/Plan/Distributed Plan
  - Budget Updates
  - Availability Control
- Revenues
  - Annual Overview
  - Structure
  - Plan/Actual/Variance

**Standard Hierarchy Reports**

- Plan Contribution Margin
- Actual Contribution Margin
- Quotation/Order/Plan/Actual
- Project Results
- Incoming Orders/Balance
- Payments
  - Receipts/Expenditures in Fiscal Year
  - Receipts/Expenditures for all Fiscal Years
  - Expenditures
  - Revenues

## Cost Element Reports

### Use

You can use cost element reports to evaluate one or more projects in detail by cost element. The reports contain the following information on costs and revenues:

- Values
- Quantities
- Confirmed hours from activity allocations
- Statistical key figures

You use cost element reports to evaluate the following data in detail:

- Detailed information on the totals records
- Planned costs from the network costing
- Reconciliation results within project processing

### Features

The standard system contains various cost element reports. You can use the Report Painter functions to copy the standard reports and adapt them to meet your needs, or to define new reports.

For details of the standard reports delivered, see [Standard Cost Element Reports \[Page 96\]](#).

You can evaluate the following objects or object intervals in the Project System:

- Project definitions
- Work breakdown structure
- Networks
- Orders
- Materials in networks (valuated stock only)

Cost element reports are created using the Report Painter, which means the Report Painter functions are available in your reports. However, you can use the Report Writer instead.

---

**Report Painter Reports**

## Report Painter Reports

### Use

You can use the Report Painter to summarize line items, in the form of totals records, according to your own criteria.

### Prerequisites

Report Painter reports are initially available in the delivery client only. You must first transport the cost element reports to the target client and generate them there.

For more information, see the step on the information system in the Project System IMG.

In the *Information System* menu, choose *Tools* → *Cost Element Reports* to find the functions for defining and generating reports.

### Features

The system automatically summarizes each individual transaction in a totals record. The summarized figures are then stored in the CO totals records files. You can use Report Painter reports to analyze the totals records files.

You can branch from the report to the line items and to the original documents.

Using extracts and selection parameter defaults you define yourself makes accessing Report Painter reports a lot easier. When you create extracts, the data selected is stored in a special table. This means that accessing reports using extracts saves the time spent reading data from the database.

With the Report Painter, you can define a report quickly and easily. (The Report Painter includes most of the Report Writer functions, but is much easier to use.) You define the report on screen, using rows and columns. As you do this, the system displays the report as it will appear when you run it. You do not need to create sets. You can enter characteristic values directly. You can divide your reports into sections and column blocks.

### Activities

To reach the Report Painter menu, go to the Information System menu and choose *Tools* → *Cost Element Reports* → *Define*.

You only need to define your own reports if the standard reports do not cover your requirements.

For more information on Report Painter reports, read [Report Painter Reports \[Ext.\]](#) in the *FI-SL Special Ledger* documentation.

## Accessing Cost Element Reports

### Prerequisites

Cost element reports are initially available in the delivery client only. Your first task is to transport them to the target client and generate them there.

Cost element groups are a great help in ensuring the reports are clear and concise. Experience has shown that two-level cost element groups are particularly useful.

You can define your own cost element groups in the Project System IMG.

For more information, see the step on the information system in the Project System IMG.

### Procedure

1. You can access cost element reports by choosing one of the following paths in the Easy Access menu:
  - *Information System* → *Financials* → *Costs* → *Plan-Based*
  - *Information System* → *Tools* → *Cost Element Reports* → *Define* → *Report Writer* → *Group*
2. Enter the controlling area, if required, and choose *Continue*.
3. The system displays the dialog box *Enter Profile*.
4. Enter a database profile.
5. The selection screen is that for the logical database. You can enter the following parameters:
  - *Project*
  - *WBS element*
  - *Network/order*
  - *Activity/operation*
  - *Materials*

In all of the above, you can enter either single objects or ranges of objects. Multiple selection is also available. The entries you make can be saved as a selection variant. You can access this variant again if you need to view this data again. The use of variants improves system performance because the system does not need to select the data from the database again.
6. If required, you can also enter the cost elements, cost element group, or cost element range you want to access in the report, if they are not the ones the system proposes.

The report contains a separate line for each of the cost elements and nodes in the cost element group. A node summarizes the values for all the cost elements in that node.
7. Start the program online by choosing *Program* → *Execute*. Alternatively, you can run the program in background processing by choosing either *Program* → *Execute in background* to run the program immediately or *Program* → *Schedule background job* to plan later background processing for the report.

---

**Accessing Cost Element Reports**

Cost elements, where costs have, in fact, been incurred, but which are not contained in the cost element group, are not displayed in the report. The project balance may, therefore, be displayed incorrectly.

The cost element report always shows the costs for the whole subhierarchy.

## Functions for Executing Cost Element Reports

### Use

The following tables give an overview of the functions you can use to execute cost element reports. You can run cost element reports online or in background processing.

### Procedure

#### Functions in the *Program* menu

Execute	The system reads the data and displays it on the screen.
Execute and print	The system reads the data, displays it on the screen, and prints it.
Execute in background	The system runs the program in background processing now.
Schedule background job	You can schedule the program for execution later - say, during the night - as a background job.

#### Functions in the *Edit* menu

Selection options	Selection options indicate whether the selected values are bigger/smaller than, or the same as, the selected values.
Delete selection criterion	If you have specified more than one project and/or project interval in the selection screen, you can delete the project/project interval just displayed from the selection.
Delete entire selection line	All the specified objects are deleted from the selection.
Dynamic selections	You can select fields from, for example, the project master data for inclusion in program processing.

#### Functions in the *Goto* menu

Variants → Save as variant	The selection criteria entered, including the user-defined selections, status selection profile, and selection options are saved as a variant. You can use variants to, for example, schedule reports for periodic background processing.
----------------------------	---

#### Functions in the *Environment* menu

Extract directory	Choose this to access the directory of Report Writer extracts.
Extract management settings	Use this menu option to display the settings currently in place to manage your extracts.
Options	Use these to determine, for example, what the list output should be or whether office integration is active.

**Functions for Executing Cost Element Reports**

Tech.information	Choose this to view information on the environment and programs applying to this report.
Change database profile	You define the database profile in customizing. It controls, for example, whether the evaluation includes the project hierarchy, networks, orders for the project, and so on. Use this menu option to make temporary changes to the profile.
Other database profile	Use this menu option to choose a different database profile for your processing this time.
Status sel.profile	You can use the status selection profile to restrict selection to objects which meet the requirements for a particular combination of statuses

For more information on the functions in cost element reports (Report Painter reports), read the *Interactive Information System* documentation under *Cost Center Accounting in CO Overhead Controlling*. To find out how to create your own Report Painter reports, read [Report Painter Reports \[Ext.\]](#).

## Branching to the Line Item Report

### Use

From the cost element report, you can call up the line item report for a cost element.

### Procedure

1. Select a cost element by choosing *Edit* → *Select block*.
2. Choose *Edit* → *Report access*.  
The *Choose Report* dialog box appears. The dialog box contains a list of the reports available using the report/report interface.
3. Choose the line item report for actual, plan, or commitment values.

---

**Standard Cost Element Reports**

## Standard Cost Element Reports

The standard system includes the following cost element reports:

### Costs, plan-based

- 6PP1 - Act./Commt/Total/Plan in COA Curr.  
Actual, commitment, and plan values. The total represents the actual and commitment costs added together; it therefore represents all the costs assigned.
- 6PP2 - Plan/Actual/Absolute Var./% Var.  
Comparison of actual and planned costs. The figure in the absolute variance column is calculated by deducting the planned costs figure from the actual costs figure. The last column shows the percentage variance, compared with the planned costs.
- 6PP3 - Plan/Actual Comparison - Period  
Compares plan and actual values at period level
- 6PP4 - Actual - Period Comparison  
Displays actual values for a fiscal year, broken down by period
- 6PP5 - Commitment Period Comparison  
Displays commitment values for a fiscal year, broken down by period
- 6PP6 - Plan - Period Comparison  
Displays plan values for a fiscal year, broken down by period
- 6PP7 - Statistical Key Figures/Periods
- 6PPA - Results analysis categories
- 6PPB - Work in Process
- 6PPF - Fixed Prices in CO Area Currency  
Displays actual, commitment, and plan values. In the case of the plan values, the costs and revenues from fixed price agreements are included.
- 6PPP - Plan/Actual comp. with partner  
Values from the plan/actual comparison are displayed in the object and in the relevant partner object.
- 6PPR - Debits in Obj.Curr./CO Area Currecy  
Displays actual costs in object currency and controlling area currency
- 6PPV - Comparison of 2 Plan Versions  
Displays the plan values from the plan versions and the differences between them
- 6PS1 - Object list for report 6PP1
- 6PSF - Object list for report 6PP7



## Line Item Reports

# Line Item Reports

## Use

Business transactions are documented as line items and stored in line item files. The data in these files is divided into plan transactions and actual transactions.

Line items are always documented for actual and commitment data. At least one line item is written for each posting. The system writes plan line items only under certain conditions.

You can use line item reports to obtain flexible analyses of individual postings per various criteria, and information on individual plan, actual, and commitment value transactions.

## Integration

You can access line item reports directly from the application or from other reports.

## Prerequisite

- Plan line items for costs and revenues are only written if the user status of the project or WBS element so permits. If the integrated planning indicator is set in the CO version, the system writes line items regardless of the user status.

**See also:**

[Plan Line Items for Costs and Revenues \[Page 103\]](#)

- Payment line items are not recorded unless Project Cash Management is active. Also, the commercial transaction *FIPA* must be assigned to a number range interval.

For more information, see the step on payments in the Project System IMG.



The system does not write plan line items for the unit costing at cost element level or for the network costing.

## Features

The following line-item reports are available for project evaluation purposes:

- Actual line items  
Actual line items are written each time you post costs, revenues, and payments.
- Plan line items  
Plan line items are written for cost, revenues, and payments if you have configured the system accordingly.
- Commitment line items  
Commitment line items are created as a commitment is set up - for example, for a purchase order.
- Budget line items  
The system uses line items to document budget changes which you save.

- Settlement line items

A distinction is drawn between primary and secondary plan/actual line item postings. Primary postings are those transferred to Controlling from external accounting; secondary postings are postings in internal accounting.

We deliver the following standard reports:

- Project actual cost line items
- Project commitment line items
- Project plan cost line items
- Project structure planned cost line items
- Project budget line items
- Project actual payment line items
- Project planned payment line items
- Display project settlement line items
- Results analysis line items

The line items selected are compiled into a list on the basis of the posting documents. You can change the format of the list by choosing different display variants. The standard system includes display variants. However, you can define additional display variants yourself and use these instead.

A number of functions support you in analyzing line items using the line item report display. These include:

- Sorting
- Filters
- Totaling
- Search

Flexible field selection means that you can include attributes of your own in the reports, such as:

- Texts
- Partner object
- Personnel number

The system manages the values in controlling area, object, and transaction currency.



If you are working with transfer prices (meaning that you have activated the valuation profile in the controlling area) you can choose the valuation you want displayed in the line item report by choosing *Extras* → *Valuation view*.

For more information on transfer prices, go to the SAP Library and choose *Enterprise Controlling* → *Profit Center Accounting*.

---

## Line Item Reports

You can analyze individual line items in more detail by branching directly to the document display.

### Activities

For a detailed description of line item reports, go to the CO Overhead Controlling documentation and choose *Cost Center Accounting → Info System → Cost Center Accounting Information System → Important Standard Reports*.

For details of how to define display variants for line item reports, read [Display Variants \[Ext.\]](#) in the *ABAP List Viewer* documentation.

## Accessing Line Item Reports

1. Go to the *Information System* item in the Project System part of the SAP Easy Access menu and click on the right-pointing arrow next to the item. Then choose *Controlling* → *Line Items*.

The system expands the point to show a list of the available line item reports.

2. Select the desired report.

The system may ask you to enter a controlling area and a database profile. Line item reports are displayed per controlling area.

3. To change the controlling area if you wish, choose *Extras* → *Set controlling area*.
4. Enter the selection criteria in the initial screen. You can access line item reports for the following objects or object intervals:
  - *Project*
  - *WBS element*
  - *Network/order*
  - *Activity*

You can enter the following additional selection conditions:

- *Cost elements*

Enter a cost element, cost element interval, or cost element group.

- *Posting dates* in actual and commitment line items

In the case of actual line item reports, enter the date or timeframe in which the line items are to be selected.

In the case of commitment line item reports, enter the date or timeframe in which the line items are to be selected. Select the *Open items only* field if you want to restrict the display to items which are still open.

- *Plan data* in plan line items

In the case of plan line items, specify the plan version, period, and fiscal year.

- *Budget data* in budget line items

In the case of budget line items, specify the fiscal year and whether you want to display the overall values as well as the annual values.

- *Payment dates* in payment line items

In the case of payment line items, specify the date on which payment is due or the expected payment date.

5. In the *Settings* area, you can specify a standard display variant, or one you have defined yourself, to determine how the data appears in the document display.

The display variant controls which fields are displayed in the basic list for the line item reports, such as:

- *Document number*

## Accessing Line Item Reports

- *Document date*
- *Document type*
- *Posting date*

For more information on display variants, read [Display Variants \[Ext.\]](#) in the ABAP list viewer documentation.

6. To ensure good system performance when accessing line item reports, choose *Further settings* and set the *Variant fields only* indicator. The result of this is that only those fields needed for the current variant are selected from the database. If you do this, however, only limited changes to the chosen display variant are possible in the line item display.

If you need the full range of variant definitions, deactivate the *Variant fields only* indicator.

7. The following additional functions are also available in the initial screen:
  - Define selection options for the selection criteria
  - Delete the entries for individual selection lines or all entries
  - Restrict the selection using the value type and other selection criteria
  - Save your selection screen input in a variant and use this variant when you access this report again
  - Read archived line items. To do this, choose *Extras* → *Data source*.
8. You have the following alternatives:
  - To run the line item report online, choose  *Execute*.
  - To execute the report online and print it immediately, choose *Report* → *Execute and print*. If you choose merely *Execute*, you can print the report later from the display, or export it to external programs.
  - To execute the line item report in the background, choose *Report* → *Execute in background*.

For more information on the functions in line item reports, read [Line Item Reports \[Ext.\]](#) in the CO - *Cost Center Accounting* documentation.

For more information on background processing, read [Background Processing \[Ext.\]](#) in the BC-*Computing Center Management System* documentation.

### See also:

[Displaying Line Item Reports \[Ext.\]](#)

## Plan Line Items for Costs and Revenues

In project cost planning, line items are only created if the project or WBS element has a user status to which the business transaction "Plan line items" is assigned. This being the case, plan line items only document the changes made from the time when planning documents are written for a project or WBS element.

In planning, you can define whether line items should be written in a plan version for cost and revenue planning activities.

If planning integration is active in the fiscal-year-dependent parameters of the relevant planning versions, the system writes cost element planning line items for plan-integrated WBS elements, regardless of user status.

You make the setting in the *Costs* component of the Project System IMG.



The system does not write plan line items for the unit costing or for the network costing.

---

**Displaying CO Documents**

## Displaying CO Documents

### Use

When you make actual/plan postings, such as settlements, transfers, or activity allocations, in CO objects, this generates CO documents. You can display these documents and the original documents recorded in Financial Accounting.

### Prerequisites

You can only display CO documents if line items were recorded for them.

See [Line Item Reports \[Page 98\]](#)

### Procedure

1. Go to the Information System menu item in the Project System part of the Easy Access menu and choose *Financials* → *Display Document*.

The system lists the available reports.

2. Select the desired report and choose *Execute*.

The system may ask you to enter a controlling area and a database profile. CO documents are displayed per controlling area.

3. To change the controlling area if you wish, choose *Extras* → *Set Controlling Area*.

4. Enter the document number.

### Result

The system produces a list of CO documents per the specified search criteria. Use the line item reports if you want to evaluate them further.

In the event of defective line items, you can trigger corrective postings from the report or document display. To do this, choose *Extras* → *Application for Correction*. See the documentation for Cost Center Accounting for more details.



The CO document display always shows the complete document, regardless of whether the relevant partner object meets the selection criteria. This means, for example, that you can see the credit in the partner object for an activity allocation.

For more information on the document display options, read [Document Display Basic List \[Ext.\]](#) in the *CO Cost Center Accounting* documentation.

## Project Summarization

### Purpose

You can use this component to combine a number of projects, internal orders, and production orders with characteristics in coming, thereby achieving more efficient cost accounting over them. This makes for clearer cost analysis at higher levels.

### Implementation Considerations

Project summarization is effected using master data fields. The advantage of this is that you can execute the inheritance run for master data fields separately from the actual summarization run. This significantly improves system performance.

If you were using summarization before Release 4.5, your projects are summarized by classification. We recommend that you convert to summarization by master data fields. Support for summarization by classification is likely to be withdrawn in the medium-term. For more information, go to the Project System IMG and choose *Information System → Responsibility Accounting*.

The text which follows describes summarization by master data field. For more information on summarization using classification, read [Summarization Using Classification \[Page 118\]](#).

The new summarization, by master data, has the following advantages:

- Clearer data structures make selection easier and faster.
- Summarization is separated from inheritance. It is not necessary to repeat inheritance every time you run summarization.
- Inheritance now uses the logical database.
- Inheritance can be split into a number of small inheritance runs.
- Projects, orders, and so on, can be summarized into one hierarchy, provided that the hierarchy characteristics have the same name.
- There is less customizing work to do.

### Integration

You can summarize projects along with orders, such as internal orders and production orders. The orders need not be assigned to the project.

The summarized data is then always available for evaluation in the information system.

### Features

Summarization combines the objects with attributes in common by means of a hierarchy structure you define yourself. The controlling area is always the top node in the hierarchy. Examples of summarization criteria include:

- Business area
- Responsible cost centers
- User-defined fields

## Project Summarization

See [Summarization Hierarchy \[Page 107\]](#).

With the summarization, you can first gain an overview of objects, then process and analyze groups of objects - for example, those with large variances.

You can evaluate the summarization data using the hierarchy and cost element reports in the project information system. The standard system contains both hierarchy reports and cost element reports.

## Constraints

In summarization, the system ignores:

- Networks which do not reference projects
- Plan values from non-appended networks and orders

## Summarization Hierarchies

### Definition

The summarization hierarchy is an analysis tool which you can use to summarize upwards through hierarchies you have defined. You use the summarization hierarchy to stipulate the fields used for the data summarization and which object types (examples: project, internal orders) are summarized.

### Use

You use the summarization hierarchy in project management to summarize the transaction data for a particular timeframe and analyze it in various views at higher levels (example: project manager level).

The summarization hierarchy combines the objects per the nodes in the summarization hierarchy and stores the original data in summarized form in the database. You can access the data quickly at any time in the information system.

### Structure

You use the summarization master data fields to define the individual hierarchy nodes in the summarization hierarchy. The master data fields available are those prescribed by SAP, plus the additional fields from customer enhancement CNEX0025. In summarization data maintenance, the system lists all the valid master data fields in the input help for the hierarchy fields.

The controlling area is always the top node in the summarization hierarchy. Below this, you can define the hierarchy levels as you require. For example, you can stipulate that your projects are summarized per the following structure:

- Controlling area (required)
- Project manager
- WBS element

You can then view all the data for a particular project manager and analyze the individual values for the WBS elements for this manager.

You also stipulate the object type you want to summarize. You can choose from the following:

- Internal orders
- Plant maintenance order and service orders
- Production orders
- Projects
- Sales orders

If you choose summarization of projects, dependent object types, such as networks, are automatically included in the summarization.



If you summarize different object types together, the summarization nodes (fields used for the summarization) must have the same name in the various objects.

---

**Summarization Hierarchies**

You stipulate the setup for a summarization hierarchy by means of a hierarchy ID in one of the following:

- Project System IMG
- Information system menu

For detailed information on setting up the summarization hierarchy, refer to the *Information System* component in the Project System IMG.

## Summarization in Projects

### Purpose

With the help of summarization in projects you can summarize your project according to fields and corresponding to the summarization hierarchy. You can analyze the result in the Information System.

The following are available for use as summarization fields:

- Master data fields selected by SAP
- Additional fields created using the customer enhancement CNEX0025

You can summarize and analyze your projects using further objects, such as internal orders.

### Prerequisites

Activate the projects for summarization using master data fields. To do this, proceed as follows:

- New project (WBS or network)
  - You must set the *Project summarization* indicator in the project profile or network profile.
  - Create the WBS or network using templates or standard structures. The template or standard structures is activated for summarization using master data fields.
- The project is summarized with summarization using classification.

In the Implementation Guide (IMG) start the conversion report *Conversion: Free Classification Chars. -> User-Defined Chars. (RCJCLMIG)*. You can then only summarize the project using master data fields.

If you do not run the program, you cannot use project summarization using master data fields for these projects.



If you create a project for a standard project or using a template, the summarization is activated in line with the template, regardless of the settings in the profile. For example, you create a project using a template where summarization using classification is activated. The new project adopts this setting.

The table below shows an overview of the criteria the system uses to determine the type of summarization for a newly created object:

Object	Summarization
New WBS element	Per the setting in the project profile
WBS element for template or standard WBS	Per the template or standard WBS
New network activity	Per the setting in the network profile
Network for template	Per the template

## Summarization in Projects

Network for standard network	Per the setting in the network profile
Activity for WBS element in structure planning	Per the WBS element



If you want to use summarization using master data fields for all your new projects, you must amend the project profiles in the Project System IMG accordingly.

## Process Flow

1. Define the summarization objects in your project. In master data maintenance, select the *Project summarization* indicator. This stipulates that the object is a summarization object. The number of summarization objects in a project affects the performance in inheritance and summarization runs.

If you have used a customer enhancement to select additional fields as summarization fields, maintain the summarization fields for the object in the *Summarization* tab page in master data maintenance.

2. Execute the inheritance run.

The system first selects all the project objects which satisfy the selection criteria. It then determines the summarization objects and inherits all the master data fields (master data characteristics and additional fields from the customer enhancement). Objects which are not summarization objects are clearly assigned to the superior summarization object. The summarization objects and relevant master data fields are stored in the database in table PSERB.

See [Executing Inheritance Run \[Page 112\]s](#).

3. Choose *Project System* → *Information System* → *Tools* → *Summarization* → *Inheritance Evaluation* to analyze the result of the inheritance run.
4. Create the [summarization hierarchy \[Page 107\]](#):

- In the IMG for Project System under *Information System*.
- By choosing *Project System* → *Information System* → *Tools* → *Summarization* → *Hierarchy*

5. Execute the summarization run. You execute the summarization run as often as you like and do so for different summarization hierarchies.

During the summarization run, the system sets up the summarization hierarchy based on the data from the inheritance run. The individual summarization nodes consist of master data fields from the summarization hierarchy. Based on the summarization criteria from the inheritance run, the system determines the objects belonging to a summarization node, selects the transaction data from the database, and updates the totals by period and cost element in the individual summarization nodes.

See [Executing Project Summarization \[Page 114\]](#).



During the inheritance run, the system merely determines the master data fields for the individual objects and stores them in a table. It is not until the summarization run that the system sets up the hierarchy per the chosen view and based on the data determined in the inheritance run. The summarization run does not take account of master data changes made after the inheritance run.

## Result

All the transaction data from the relevant objects is summarized in the summarization nodes. You can evaluate the summarized data by period in the project information system at any time, using hierarchy reports or cost element reports.

If you are also using the Executive Information System (EIS) component, you can transfer the master data fields determined in the inheritance run to the EIS and analyze them (see [Transferring Data to EIS \[Page 128\]](#)).

## Executing Inheritance Runs

# Executing Inheritance Runs

## Use

The summarization hierarchy is set up and the data summarized on the basis of the summarization fields determined in the inheritance run.

If you are using the Executive Information System (EIS), data from the master data fields of the summarization objects is transferred to EIS.

See [Transferring Data to EIS \[Page 128\]](#)

The inheritance run is a prerequisite for the summarization run and the data transfer to EIS, both of which you carry out separately.

## Prerequisites

Inheritance is always per controlling area.

The project must be defined for project summarization using master data fields.

Projects activated for summarization using classification can be converted to classification using master data fields by means of program RCJCLMIG which you run in the Project System IMG.

## Procedure

1. Go to the Project Information System menu and choose *Tools* → *Summarization* → *Inheritance*.
2. The system may ask you to enter a controlling area and a database profile. Enter a database profile with the structure-oriented view.
3. Specify one or more projects.
4. You can use highlighting and a status selection profile to restrict the selection further.  
You can use highlighting to have the system use traffic lights to highlight particular nodes in a summarization hierarchy.  
See [Highlighting \[Ext.\]](#)  
You can use the status selection profile to restrict selection to objects which meet the requirements for a particular status. For example, you can summarize the projects which have status "Released".
5. Select the process control fields you require: The following options are available:
  - Background processing
  - Test run
  - Delete  
All the summarization fields from an earlier inheritance run for the selected objects are deleted. The objects are not then included in the next summarization run.
  - Error log
  - List: Projects

**Executing Inheritance Runs**

When the inheritance run is complete, the system outputs a list of all the projects processed. You can access the message log from the list. The message log lists any errors which occurred and information messages for the summarization.

- All projects

The system redetermines the summarization fields for all objects. Otherwise, the system redetermines the summarization fields only for the projects where relevant master data changes have taken place.

6. Choose *Execute*.

**Result**

In the inheritance run, the system passes on the master data fields to the summarization objects, per the master data hierarchy determined.

The system assigns the same characteristics to objects which are not summarization objects as to the summarization object superior to them in the hierarchy.



A WBS element is flagged as a summarization object. Within the project hierarchy, activities are assigned to the WBS element and material components and production orders are assigned to the activities. All these objects inherit the master data characteristics of the WBS element.

When online inheritance is complete, the system outputs any messages which occurred.

## Executing Project Summarization

# Executing Project Summarization

## Use

You use the summarized data from the project summarization for controlling purposes covering your whole business. You can use summarization to analyze different views of your projects.

## Prerequisites

The summarization objects determined in the inheritance run and their master data fields form the basis for setting up the summarization hierarchy. You must have carried out the inheritance run at least once.

If there have been any master data changes since the last inheritance run, you should run it again before the summarization run. This is the only way of ensuring that all data per the current project status is included.

Summarization is by controlling area. Objects not assigned to the controlling area are not included in the summarization.

## Procedure

1. Go to the Information System menu in the Project System part of the Easy Access menu and choose *Tools* → *Summarization* → *Summarization* to access the CO summarization.
2. Enter the controlling area, as required.
3. Specify a hierarchy or subhierarchy.

- *Hierarchy*

Choose *Extras* → *Summarized hierarchies* to obtain a list of the summarization hierarchies already summarized.

- *Subhierarchy*

If you only want to summarize a subhierarchy, choose the arrow icon. The subhierarchy dialog box appears. It contains a list of all the characteristics in the summarization hierarchy. Enter the characteristic values for which you want to carry out project summarization.

4. If you have defined exceptions for the summarization hierarchy, choose *Extras* → *Exception* → *Define rule* to activate them for this summarization run.

By defining exceptions, you stipulate that the system highlights particular nodes in the hierarchy per the exception, using traffic lights.

5. Select *Summarization run* and specify periods and fiscal year between which summarized data is to be considered.



The system considers the overall structure plan values, the overall budget, and the unit costing, regardless of any “from” and “to” specifications made.

6. You can run project summarization online or in background processing. We supply summarization set to background processing because the summarization run can take some time.

## Executing Project Summarization

7. Alternatively, you can choose the following parameters:

– *Hierarchy without data*

It is possible to generate summarization hierarchies with no data. The system merely sets up the summarization hierarchy again. New nodes may be inserted into the hierarchy. Transaction data is not selected afresh.

You can then evaluate the hierarchies in, for example, the hierarchy reports. The system reads the data interactively and assigns it to the appropriate view. For performance reasons, we recommend that you use this procedure in very large structures. Use *Tools* to access the view in the hierarchy reports.

– *Deletion run*

The system deletes all the nodes for the hierarchy, along with the transaction data. You can then change or delete the hierarchy itself.

8. Choose  *Execute*.

## Result

The system sets up the summarization hierarchy according to the master data fields of the summarization objects from the inheritance run, selects the accompanying transaction data, and updates the result in the individual summarization nodes. The project information system includes flexible reports for analyzing the summarization hierarchy.

When the online summarization is complete, the system outputs an overview log which shows the nodes processed.

You can access the following functions:

- *Message log*

The message log lists any errors which occurred and information messages for the summarization.

- *Table statistics*

The table statistics detail how many totals records were written in the summarization.

In the initial screen, you can also:

- *Maintain texts*

Use this function to enter names for the different levels in the hierarchy.

- *Display texts*

Use this function to display the names for the different levels in the hierarchy.

## Accessing Project Summarization Reporting

1. In the project information system part of the Easy Access menu, choose *Financials* → *Summarization*.
  2. Select one of the ready-defined summarization reports: Both drilldown reports and cost element reports are available for summarization purposes.  
See [Standard Reports in Summarization \[Page 117\]](#)
  3. Enter the required data in the following fields:
    - *Hierarchy type*  
Enter PR if you are still using the old summarization (by classification). Otherwise enter CO.
    - *Hierarchy ID*  
Use the *Hierarchy overview* pushbutton to obtain a list of the hierarchies active in the controlling area.
    - Choose *Extras* → *Summarized hierarchies* to obtain a list of the summarization hierarchies already summarized.
    - *Subhierarchy*
- The report is then displayed per the criteria selected.

## Standard Summarization Reports

The system includes standard hierarchy and cost element reports for project summarization. The list below shows some of the standard reports available.

### General

- Overview: Project Hierarchies
- Costs/Revenues/Expenditures/Receipts

### Cost Element Reports

#### Costs

- Actual/Plan/Variance
- Actual/Plan/Commitment
- Current/Cumulative/Total

#### Budget

- Budget/Actual/Variance
- Budget/Actual/Commitment

#### Revenues

- Order Profit
- Actual/Plan/Variance
- Current/Cumulative/Total

### Hierarchy Reports

#### Costs

- Plan/Actual/Variance
- Plan/Actual/Commitment

#### Budget

- Budget/Actual/Variance
- Budget/Actual/Commitment

#### Revenues

- Plan/Actual/Variance
- Planned Contribution Margin
- Actual Contribution Margin

### Other

- Payments: Overview

## Project Summarization Using Classification

### Use

With summarization, you can summarize transaction data in a controlling area according to different views. You can access this data in the information system, thereby improving information system performance.

In this way, you can, for example, combine and evaluate the costs for all the projects for a:

- Controlling area
- Business area
- Cost center
- Responsible person

The data is summarized using hierarchy structures you define yourself. In the CO System, project summarization is realized via the SAP classification system.

For information on classification, read the documents *MM - Classification* and *MM - Characteristics*.



Support for summarization by classification is likely to be withdrawn in the medium-term. Use summarization using master data characteristics instead. Projects activated for summarization using classification can be converted to classification using master data fields by means of program RCJCLMIG which you run in the Project System IMG. For more information, go to the Project System IMG and choose *Information System* → *Responsibility Accounting*.

### Features

Project summarization includes the following functions:

- Budget and structure plan values  
You can summarize budget and structure plan values independently of cost elements.
- Network activities and activity elements
  - **Header-assigned networks** are summarized using class type 13. If you set the appropriate indicator in customizing, header-assigned networks are automatically classified for summarization.
  - **Activity-assigned networks** are classified using class type 14.
- Orders for the project  
The project summarization includes only the plan values for appended orders.
- Evaluation  
You can use the dynamic data-recall facility to produce flexible evaluations.
- You can evaluate summarized data from different points of view.



## Characteristics

# Characteristics

## Definition

A "characteristic" is a criterion according to which data can be summarized.

## Structure

You use characteristics to define the different levels of the summarization hierarchies. A distinction is drawn between the following:

- Reference characteristics, which reference fields in the project master record
- User-defined characteristics

In project summarization, proceed as follows:

- In Project System customizing:
  - To define the scope of the summarization characteristics, choose *Information System* → *Responsibility Accounting* → *Project Summarization* → *Project Summarization Using Classification Characteristics* → *Determine Characteristic Range*.
  - To define any user-defined characteristics you need, choose *Information System* → *Responsibility Accounting* → *Project Summarization* → *Project Summarization Using Classification Characteristics* → *Define User-Defined Characteristics*.

You assign the user-defined characteristics to the "project" class so that you can evaluate them in project master data maintenance.

- In the Project System:
  - Set the *Summarization* indicator in the basic data for the WBS elements you want to classify. In project summarization, this setting is passed on to the WBS elements subordinate to this one, so that, for example, the costs incurred flow into the project summarization. The parameter is not, however, set in the basic data for the subordinate WBS elements.
  - Network activity - Set indicator in profile
  - Valuate the user-defined characteristics in Project System master data maintenance.
  - Start summarization.
  - Access the summarization reports.

### See also:

- [Displaying Reference Characteristics \[Page 122\]](#)
- [Defining Your Own Characteristics \[Page 123\]](#)
- [Displaying Characteristics for a Class \[Page 124\]](#)



---

**Displaying Reference Characteristics**

## Displaying Reference Characteristics

These characteristics reference fields in the project master record and are delivered in a standard SAP table. The characteristics for projects must be generated for a client in the Project System IMG, by choosing *Information System → Responsibility Accounting → Project Summarization → Convert Classification Characteristics into Summarization Characteristics*.

As well as these characteristics, the class SAP\_KKR\_CLASS (object type CO objects; class type 014) is also generated. The characteristics generated are included in this class.

You can display the reference characteristics as follows:

1. In the Project System part of the Easy Access menu, choose *Basic Data → Project → Work Breakdown Structure (WBS) → Change*.
2. Access the project structure for a project.
3. In the detail screen for a WBS element that is part of the summarization, choose *Summarization*.

The *Change Project Characteristic* screen shows a list of the characteristics for the project.

## Defining Your Own Characteristics

In the classification system, you can create user-defined characteristics, which do not refer to fields in the project master record.

To define a characteristic, proceed as follows:

1. In the Easy Access menu, choose *Logistics* → *Central Functions* → *Classification* → *Master Data* → *Characteristics*.

The *Characteristics* screen appears, showing a number of tab pages, including Basic Data.

2. Enter a characteristic for project summarization. It must comply with the following conditions.
  - It must have format CHAR or NUM.
  - If it has NUM format, it must not have any decimal places, nor can it have a sign before it
  - No multiple values
  - In one language only
3. Having complied with these conditions, save your characteristic.

For your new characteristic to appear in master data maintenance, you must assign it to the class SAP\_KKR\_CLASS:

1. In the Easy Access menu, choose *Logistics* → *Central Functions* → *Classification* → *Master Data* → *Classes*.

This brings you to the *Class* screen.

2. Enter **SAP\_KKR\_CLASS** in the *Class* field.
3. Enter **014** (Controlling: Projects) in the *Class type* field.
4. Choose *Class* → *Change*.

The *Change Class* screen appears, showing a number of tab pages.

5. Choose the *Characteristics* tab page..
6. Enter the characteristic(s) you have defined in the list.
7. Save your work.

If access the WBS in change mode and choose the *Summarization* function for a WBS element, a list of characteristics appears. The user-defined characteristic appears at the end of the list, ready for input. You can now evaluate it.

---

**Displaying Characteristics for a Class****Displaying Characteristics for a Class**

1. In the Easy Access menu, choose *Logistics* → *Central Functions* → *Classification* → *Master Data* → *Classes*.
2. In the *Class* screen, enter the class **SAP\_KKR\_CLASS** and choose *Class* → *Display*.  
All the characteristics belonging to this class are displayed.

## Alternative Hierarchies in Summarization

You can use different views to evaluate the summarized data, depending on the database profile. Note the following when working with views in summarization:

- In the view *Characteristic Hierarchy from Classification*, the hierarchy is set up by reconstructing the summarization. Before accessing the report with this view, you must choose *Tools* → *Summarization* in the information system menu.
- You can set up the summarization without data. To do this, choose *Tools* → *Summarization* → *Hierarchy*. Restrict the scope of your data to the totals records table (FMSUA) by deactivating the *No sum* indicator. When setting up the hierarchy, choose fiscal year 9999.  
When you access this view, the system reads the summarization hierarchy and sorts the selected objects accordingly.
- You can improve system performance in the attribute hierarchy from classification with a flat object list by breaking summarization down only as far as a particular level. The system then sets up the project hierarchy as far as this level only.
- For more information on the project view, read the documentation on logical database SAPDBPSJ (transaction SE38) or in the Project System IMG under *Information System*.

---

**Executing Summarization Using Classification**

## Executing Summarization Using Classification

### Procedure

To summarize projects using an existing hierarchy identification, proceed as follows:

1. In the *Information System* area menu, choose *Tools* → *Summarization* → *Using Classification*.
2. The *Controlling area* dialog box appears.
3. Enter the controlling area for which you want to carry out project summarization.
4. The *Project Summarization* screen is displayed.
5. Enter the following data:
  - *Hierarchy ID*  
Use the *Hierarchy overview* pushbutton to obtain a list of the hierarchies active in the controlling area.  
  
Choose *Extras* → *Summarized hierarchies* to obtain a list of the summarization hierarchies already summarized.
  - *Subhierarchy*  
If you only want to summarize a subhierarchy, choose the arrow icon. The subhierarchy dialog box appears. The system displays a list, showing all the characteristics for which a summarization is carried out. Enter the characteristic values for which you want a project summarization now.
  - *From period/fiscal year* and *To period/fiscal year*.
5. Set *Summarization run* indicator and choose *Execute*.

The system displays a dialog box, where you confirm the project summarization.

Select the *Background processing* indicator if you want to run the summarization in the background.

The next screen is an overview, showing the hierarchy nodes processed.



It is possible to generate summarization hierarchies with no data. You can then evaluate the hierarchies in, for example, the hierarchy reports. The data is read interactively and assigned to the appropriate view. For performance reasons, we recommend that you use this procedure in very large structures. Use *Tools* to access the view in the hierarchy reports.

**See also:**

[Alternative Hierarchies in Summarization \[Page 125\]](#)

### Result

After the online summarization, the system displays an overview screen, which shows the hierarchy nodes processed.

---

**Executing Summarization Using Classification**

You can access the following functions:

- *Message log*  
The message log lists any errors which occurred and information messages for the summarization.
- *Table statistics*  
The table statistics detail how many totals records were written in the summarization.

The following functions are also available:

- *Maintain texts*  
Use this function to enter names for the different levels in the hierarchy.
- *Display texts*  
Use this function to display the names for the different levels in the hierarchy.

## Transferring Data to EIS

# Transferring Data to EIS

## Purpose

The EIS (Executive Information System) is the information system for management. It is suitable for collecting and evaluating data from different functional areas in your business in one uniform view.

You can use EIS to evaluate accounting key figures (such as costs, revenues, budget, and payments) together with logistics key figures (work, dates, duration, and so on) summarized by master data characteristics from the summarization inheritance run, using master data fields.

See [Executing the Inheritance Run \[Page 112\]](#).

## Prerequisites

Your projects must take part in the project summarization using master data fields.

You must do the following in the EIS and Project System IMGs:

- Generate the important Project System key figures in the following sender structures:
  - PSGENACC (Accounting key figures)
  - PSGENLOG (Logistics key figures)
- Set up the report program for the data transfer

## Process Flow

1. Execute the inheritance run by choosing *Tools* → *Summarization* → *Inheritance* in the project information system menu.
2. Go to the application menu for the Project System or EIS and access the data transfer or data procurement. In the Project System, you access the data transfer in the project information system menu by choosing *Tools* → *Transfer Data to EIS*.



The data transfer takes place per controlling area - meaning that the system only transfers data from projects being executed in the specified controlling area. You set the controlling area in the Project Information System menu by choosing *Environment* → *Set controlling area*.

3. The system selects the Project System transaction data which matches the selection criteria and the master data fields from the summarization run already carried out.
4. The system fills the generated transfer structures PSGENACC and PSGENLOG.
5. The system uses PSGENACC or PSGENLOG to send the project key figures determined to EIS.



Both the Project System and EIS include customer enhancements for the data transfer. For more information, refer to the Project System IMG.

## Result

The project key figures and master data fields transferred are now available for evaluation in EIS. For example, you can use formulas to define additional key figures and evaluate the data using reports defined in EIS.

For more information on EIS, read the [Implementation Information and Enterprise Planning \[Ext.\]](#) documentation.

---

**Transferring Data to the Business Information Warehouse**

## **Transferring Data to the Business Information Warehouse**

### **Use**

The Project Information System always contains the most up to date information available on your project.

However, it is possible that you may want to preserve the information available at a particular time so that you can analyze it at a later date. To this end, you can transfer the data for the time in question to the Business Information Warehouse (BW), where various analysis options are available.

### **Prerequisites**

You must have installed the Business Information Warehouse.

### **Activities**

For information on the steps involved in transferring data to BW, and on how to analyze the information in BW, refer to the BW documentation.

## Reports on Resources

### Use

You can use the resource information system to analyze the capacity requirements of the work centers used in your project.

These evaluations enable you to assess the demands which networks or production orders make on the capacity of a work center.

### Features

The project information system includes the following reports on resources:

- Capacity Requirements
- Capacity Load: Work Center View
- Capacity Load: Variable View
- Workforce Planning

To run them, go to the Project System part of the Easy Access menu and choose *Information System* → *Resources*. Then select the report you want.

In addition, you can access the following resource reports in the information system from Inventory Management and Materials Management.

### Inventory Management

- Missing parts
- Pegged requirements
- Stock/requirements list

### Materials Management

- Reservations
- Purchase requisitions
- Purchase orders
- Outline agreements

For more information on capacity evaluations, data selection, and how you can adapt the reports to suit your needs, read [PP - Capacity Evaluation \[Ext.\]](#).

---

**Selection Criteria**

## Selection Criteria

### Use

You define the type of capacity evaluation in the overall profile in Customizing for the Project System. The overall profile consists of a number of individual profiles.

- In the *selection profile* you specify the layout (sets) for the various screens containing the data for analysis.
- In the *options profile* you specify the values, for example, target and remaining requirements, to be shown in lists and graphics.
- In the *list profile* you define the layout of the capacity detail list and the variable overview.

You can change the parameters during processing.

## Defining Selection Criteria

### Selection Menu

When you call up the resource information system, you can specify additional selection criteria such as work centers, by selecting the menu options *Planning* → *Selection* on the initial screen.

The following table gives you an overview of the menus you can use to define selection criteria:

#### Selection Criteria

With the menu option...	You maintain...
<i>Planning</i> → <i>Profiles</i>	Data for the profiles
<i>Selection</i>	Selection criteria for work center, capacity category and orders. You can also form your own combinations of selection criteria.



To select a network, go to the order detail screen and enter the network type as the order type and enter the network number in the order field.

---

**Starting Evaluations**

## Starting Evaluations

### Procedure

1. From the Information System menu, choose *Resources* → *Capacity Load* → *Work Center View* or *Variable View*.

The screen *Capacity Planning: Selection List* appears:

2. Enter your data or define additional selection criteria by choosing *Planning* → *Selection*, then confirm.

The standard overview is displayed.

3. You can call up other overviews or the graphic from the *Goto* menu.

### Result

You can access the following overviews and graphics from the *Goto* menu:

- The *standard overview* displays a period-by-period comparison of the capacity requirements and available capacity in the selected work centers and the capacity committed to work centers.
- The *capacity detail list* provides a period-by-period analysis of the capacity required by individual activities.
- Using the *variable overview*, you can edit data necessary for capacity planning, such as formula parameters. Variants are stored in the list profile. You can create more variants by choosing *Settings* → *Evaluations* → *Var. overview*.
- From every overview, you can access the graphics by selecting *Goto*.

### Printing Lists

You can print the various lists by selecting the menu options *Planning* → *Print*.