

Change and Transport System - Overview (BC-CTS)



HELP.BCCTS

Release 4.6C



Copyright

© Copyright 2001 SAP AG. All rights reserved.

No part of this publication may be reproduced or transmitted in any form or for any purpose without the express permission of SAP AG. The information contained herein may be changed without prior notice.

Some software products marketed by SAP AG and its distributors contain proprietary software components of other software vendors.

Microsoft[®], WINDOWS[®], NT[®], EXCEL[®], Word[®], PowerPoint[®] and SQL Server[®] are registered trademarks of Microsoft Corporation.

IBM[®], DB2[®], OS/2[®], DB2/6000[®], Parallel Sysplex[®], MVS/ESA[®], RS/6000[®], AIX[®], S/390[®], AS/400[®], OS/390[®], and OS/400[®] are registered trademarks of IBM Corporation.

ORACLE[®] is a registered trademark of ORACLE Corporation.

INFORMIX[®]-OnLine for SAP and Informix[®] Dynamic Server[™] are registered trademarks of Informix Software Incorporated.

UNIX[®], X/Open[®], OSF/1[®], and Motif[®] are registered trademarks of the Open Group.







HTML, DHTML, XML, XHTML are trademarks or registered trademarks of W3C[®], World Wide Web Consortium, Massachusetts Institute of Technology.

JAVA[®] is a registered trademark of Sun Microsystems, Inc.

JAVASCRIPT[®] is a registered trademark of Sun Microsystems, Inc., used under license for technology invented and implemented by Netscape.

SAP, SAP Logo, R/2, RIVA, R/3, ABAP, SAP ArchiveLink, SAP Business Workflow, WebFlow, SAP EarlyWatch, BAPI, SAPPHIRE, Management Cockpit, mySAP.com Logo and mySAP.com are trademarks or registered trademarks of SAP AG in Germany and in several other countries all over the world. All other products mentioned are trademarks or registered trademarks of their respective companies.

Icons

Icon	Meaning
	Caution
	Example
	Note
	Recommendation
	Syntax
	Tip

Contents

Change and Transport System - Overview (BC-CTS)	6
Basics of the Change and Transport System	7
Change Management in the SAP System Landscape	8
Clients and Their Roles	10
System Landscape	12
Transport Organizer - Concept	15
Transport Management System - Concept	18
Basics of Transport Control	21
Transport Layers and Transport Routes	22
Assignment of Development Projects to Transport Layers.....	24
Extended Transport Control	25
Transport Strategy in the CTS	29
Transports with Import Queues	31
Mass Transports	33
Single Transports	35
Transport Workflow	37
Using Projects to Control Transports	40
TMS Quality Assurance	41
Transactions and Tools in the CTS	43
Transport Organizer	44
Functions in the Transport Organizer	45
Change Requests	46
Transports of Copies and Relocations.....	48
Transport Organizer (Extended View)	50
Piece Lists.....	51
Client Transports.....	52
Delivery Transports.....	53
Request Overview	54
Functions in the Request Overview	55
Objects in the Transport Request and IMG Activities	57
Transport Organizer Tools	58
Transport Management System (TMS)	59
User Exits in the Change and Transport System	60
Authorization Concept in the CTS	61
Roles in the Change and Transport System	62
Transport Administrator	63
Transport Operator	65
Authorizations in the CTS	66
Authorizations in the Transport Organizer	69
Authorizations in TMS.....	71
TMS Trusted Services	73
Setting Authorizations for TMS.....	74

Change and Transport System - Overview (BC-CTS)

The Change and Transport System (CTS) is a tool that helps you to organize development projects in the ABAP Workbench and in Customizing, and then transport the changes between the SAP Systems in your system landscape.

This documentation gives you an overview of how you can use the CTS to organize your changes, as well as basic information on setting up your system and client landscape and choosing a transport strategy. Read and follow this documentation when planning your development project.

For practical information on working with the Change and Transport System, see [Transport Organizer \[Ext.\]](#) and [Transport Management System \[Ext.\]](#).

Basics of the Change and Transport System

This section contains essential information on organizing your development and Customizing projects. It describes the activities that are organized by the Change and Transport System, and gives you an overview of the roles of clients and systems in a system landscape. It introduces and explains important terms and concepts.

Change Management in the SAP System Landscape

Change Management in the SAP System Landscape

Before you can use the SAP software to control the business processes in your company, you must first adapt it to your own business needs. This is usually done in an SAP implementation project. Adapting and configuring is usually an ongoing process. Even after you start using the system productively, you still need to make changes to the SAP configuration. This may be due to business or organizational changes in your company, or due to the implementation of new SAP functions. This is often linked to an upgrade to a new SAP Release.

SAP provides various tools for modifying the SAP software. Which tools you use depends on the type and extent of your business requirements. Any modifications that you make with these tools are stored in certain tables in the SAP database.

Customizing Tools

The most important configuration tool is the Implementation Guide ([IMG \[Ext.\]](#)). You can use the IMG to make all configurations possible in the SAP standard. Any modifications you make to the SAP software in the IMG are known as Customizing settings, or [Customizing \[Ext.\]](#) for short. This includes setting up organizational units (company codes, plants, sales organizations, and so on) and making settings for controlling business processes.

The IMG splits the various Customizing settings into IMG activities and displays them in a hierarchical overview. This overview shows the recommended process flow and assignment to the different applications of the SAP System. The IMG lets you filter out the relevant IMG activities for a particular section of the SAP applications. You can also group IMG activities logically into IMG Projects. These projects are then worked on as an implementation project by a particular team. You can document the requirements of a project and its progress in the IMG Project.

The changes that you make in the IMG are placed in the Customizing tables of the SAP database. The contents of these tables are known as Customizing data. When you use the SAP applications productively, the SAP runtime system analyzes this Customizing data and uses it to control your business processes.

Most Customizing data is client-specific. This means that you can choose different Customizing settings for each client in your SAP System that do not affect each other. Changes to the Customizing settings in one client have no effect on system actions in another client.

However, there is also a significant amount of cross-client data that is relevant for all clients (such as the factory calendar). Note that if you change these types of Customizing settings, it affects all clients in the SAP System.

ABAP Workbench

If the configuration options in the SAP standard are not enough to meet your requirements, you can also add to the SAP standard functions. SAP provides the ABAP Workbench as a complete programming environment. The ABAP Workbench includes tools for defining data structures (ABAP Dictionary), developing ABAP programs (ABAP Editor) and designing interfaces (Screen Painter and Menu Painter), as well as many other functions.

For example, you can use the ABAP Workbench to develop your own report programs or transactions, or to modify or make your own enhancements to existing SAP programs. These enhancements are known as customer exits. However, this does require experience of the ABAP Workbench and the SAP application where you want to develop.

Change Management in the SAP System Landscape

The changes that you make in the ABAP Workbench are placed in the Repository tables of the SAP database. The contents of these tables are known as Repository data or Repository objects. Apart from a few exceptions, the Repository data is cross-client. As with cross-client Customizing, changes to Repository objects affect all clients of an SAP System.

Change and Transport System (CTS)

The CTS is the central tool for managing changes to Customizing and Repository data that you make in the IMG or ABAP Workbench. The CTS records all changes in change requests. The changes in change requests can be linked together logically, or can be completely independent of each other. Developers in a team can use a common request. You can create documentation for a change request, where you can describe your changes in more detail. This makes it easier to see which data was changed by which user, and to what purpose.

When you have finished your work in the IMG or ABAP Workbench, or have reached a certain stage, you can release the request. The change request is then used to copy the changes from this client to other clients or systems. This automatic procedure is known as a **transport**. Transports of changes by the CTS allow you to develop in one environment, test your development work in a test environment, and then, if the tests are successful, use it productively. This makes sure that productive operations are not placed at risk by faulty settings or program errors.

Transports of changes between clients and systems are subject to rules that are set in the CTS configuration in the system landscape. One rule may be that changes are transported into a test environment before they can be copied to the production environment. All transports are logged, so that you can see when a change request was imported into a client or system, and whether there were any errors.

Application Data

In contrast to Customizing and Repository data, application data is not part of the configuration of the SAP software. Application data is the business data that the SAP applications process when you use them productively. It is split up into master data (such as material masters, customer masters and vendor masters) and movement data (such as contracts and financial documents). Application data is always client-specific.

The CTS does not manage changes to application data. It is also impossible to use the CTS to transport application data into other clients or systems.

If you want to copy master data and movement data between clients in an SAP System, or from a non-SAP system into an SAP System, or if you want to set up this data automatically, you can use other tools, such as ALE ([Application Link Enabling \[Ext.\]](#)), CATT ([Computer Aided Test Tool \[Ext.\]](#)), or use the application interfaces of the BOR ([Business Object Repository \[Ext.\]](#)).

Clients and Their Roles

Clients and Their Roles

When you log on to an SAP System, you log on to a particular client of this system. Any activities you carry out in the system are always carried out in one client. When you plan your SAP system landscape, you must consider which clients you need for which activities.

By assigning activities to be performed in a client, you give each client a particular role. This section describes the most important client roles.

Since you need to adapt the SAP software for your own business needs, each SAP system landscape requires a client where Customizing settings, and possibly ABAP Workbench developments can be made. This client is known as the *Customizing and development client*, or *Customizing client* for short. The abbreviation CUST is used for this client.

Before you can use the Customizing settings and Workbench developments productively, you need to test them extensively for errors. Any faulty settings can seriously disrupt productive operations, and at worst, lead to the loss of productive data. The integrated nature of the various SAP applications means that there are many dependencies between the different Customizing settings. Even an experienced Customizing developer may not discover these dependencies immediately. The correctness of the settings can only be guaranteed with extensive testing. The client where these tests are made is the *Quality Assurance Client*, QTST for short.

A separate client is required for productive use of the SAP System. So that this client can be used without disruption, it is essential that no Customizing settings or Workbench developments are made here, and also that no tests are carried out. This client is known as the *Production Client*, PROD for short.

These three clients, CUST, QTST and PROD, are the central clients that exist in every system landscape. Standard system landscapes have precisely one client for each of these client roles.

We recommend that you make all your Customizing settings in a single Customizing client, and then use the CTS to transport them to the other clients.

We also recommend that you do not make any Customizing settings or Workbench developments in the quality assurance or production clients. You can make sure of this by making appropriate [client settings \[Ext.\]](#).

In addition to the central clients, you can also set up other clients for other tasks. However, you must remember that each extra client takes up additional system resources (main memory and database space). They also need to be administrated. For example, you need to set up and administer access authorization for the users, and also distribute any changes to other clients with the CTS. You must weigh up the advantages and disadvantages of setting up other clients.

Examples of other client roles are:

Development test client (TEST): Developers can use this client to test their Customizing settings and Workbench developments, before they release their change requests. In this client the developers can create test application data for realistic tests. If they discover errors, they can remove them in the Customizing client. A development test client is always set up in the same SAP System as the Customizing client. This means that any changes that are made to cross-client data in the Customizing client are also immediately visible in the development test client. Changes to client-specific data are copied from the Customizing client to the development test client using a special [client copy \[Ext.\]](#) function. The client copy function uses the unreleased change requests from the Customizing client to do this. The development test client is set so that you cannot make changes to Customizing data and Repository objects.

Clients and Their Roles

Prototype or sandbox client (SAND): You can use this client to test any client-specific Customizing settings if you are not sure whether you want to use them in this form. Any settings that you want to keep are then entered in the Customizing client. To prevent conflicts between the prototype client settings and real settings in the Customizing client, you cannot make changes to cross-client Customizing data and Repository objects in the prototype client. The CTS does not record changes made to client-specific Customizing data, and does not transport them from the prototype client. You can make sure of this by making appropriate client settings.

Training client (TRNG): To prepare end users for new functions that are to be transported into the production client, you can set up a training client. The users can use the new functions in this client with specially created application data. This client is set so that you cannot make changes to Customizing data and Repository objects.

System Landscape

System Landscape

The system landscape contains all the SAP Systems that you have installed. It can consist of several [system groups \[Ext.\]](#), whose SAP Systems are linked by transport routes.

After you decide which [clients \[Page 10\]](#) you need and which roles you want them to have, you need to decide how to distribute them amongst the different SAP Systems. You can set up multiple clients independently of one another in a single SAP System. However, when you configure the data, you must remember that cross-client Customizing settings and Repository objects are identical for all clients in a single SAP System. Changes made in one client apply immediately to all clients in the system.

Three-System Landscape

We recommend a three-system landscape in which each of the central clients has its own SAP System.

This consists of a development system DEV, a quality assurance system QAS and a production system PRD. The development system contains the Customizing client CUST, the quality assurance system contains the quality assurance client QTST and the production system contains the production client PROD.

Make all changes to Customizing data and Repository objects in the Customizing client. When you release the corresponding change requests, they are transported into the quality assurance client. This means that changes to cross-client data only appear in the quality assurance client after the transport. In the quality assurance client you can test whether the transports are complete, or whether any linked changes are missing and are still in unreleased change requests. If the test is successful, the change requests are transported into the production client. The production client is completely separate from the other clients as regards cross-client data.

If you need other clients with additional roles you can set them up in one of the three systems. Set up the development test client (TEST) and the prototype client (SAND) in the development system. Set up the training client (TRNG) in the quality assurance system.

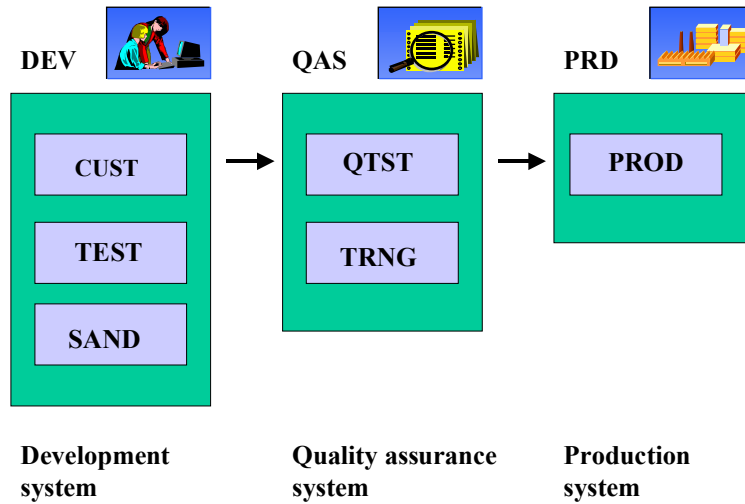

Two-System Landscape

A two-system landscape is an alternative for smaller SAP implementations where little Workbench development takes place.

The two-system landscape does not include a separate quality assurance system QAS. The quality assurance client is also in the development system DEV.

As in the three-system landscape, the production client is completely separate from the other clients. The disadvantage of a two-system landscape is that cross-client data is used in both the Customizing and quality assurance clients. This means that any changes that are made to cross-client data in the Customizing client can affect the tests in the quality assurance client. You can also not guarantee that transports from the Customizing client will be complete. Although all tests in the quality assurance client were successful, errors could still occur after the transport into the production client. This problem is caused by changes being made to cross-client data and then not being transported.

System Landscape

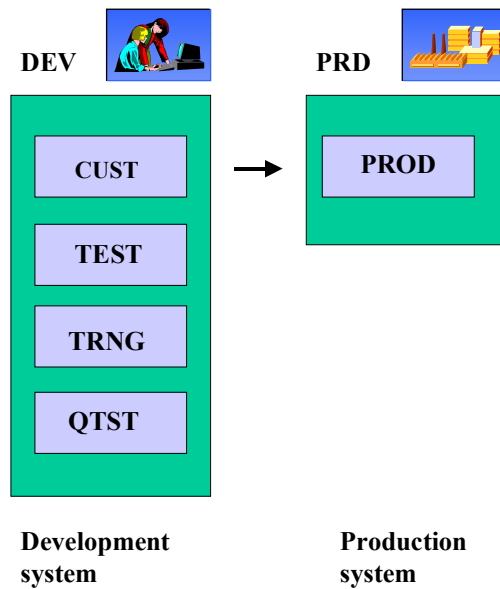

One-System Landscape

We do **not** recommend a one-system landscape containing all central clients in a single SAP System. Joint usage of hardware resources and cross-client data places serious restrictions on how a single system operates. In particular, once the system is used productively, you can no longer develop in it, unless you stop productive operation for the development and test phases.

Transport Organizer - Concept

The Transport Organizer is fully integrated into the ABAP Workbench and Customizing tools. You can navigate between them in both directions. This enables you to:

- switch to the Transport Organizer from all transactions of the ABAP Workbench and Customizing
- switch to the appropriate Workbench editor by double-clicking individual objects in an object list.

Recording Changes

The Transport Organizer records and documents all changes to objects in the Repository and Customizing:

- Repository objects, for example
 - ABAP Dictionary objects
 - ABAP programs
 - Screens
 - User interface definitions
 - Documentation
- Customizing objects, for example
 - Settings for organizational units (plants, company codes, and so on)
 - Settings for control tables

The Transport Organizer helps you when you organize development projects by allowing you to distribute project work for individual developers or teams between different **change requests**. These change requests record all changes made to development objects and Customizing settings. Objects from the areas of Customizing and the ABAP Workbench are managed and recorded in separate requests. Special checks have been implemented for each of these applications.

Transport Organizer - Concept

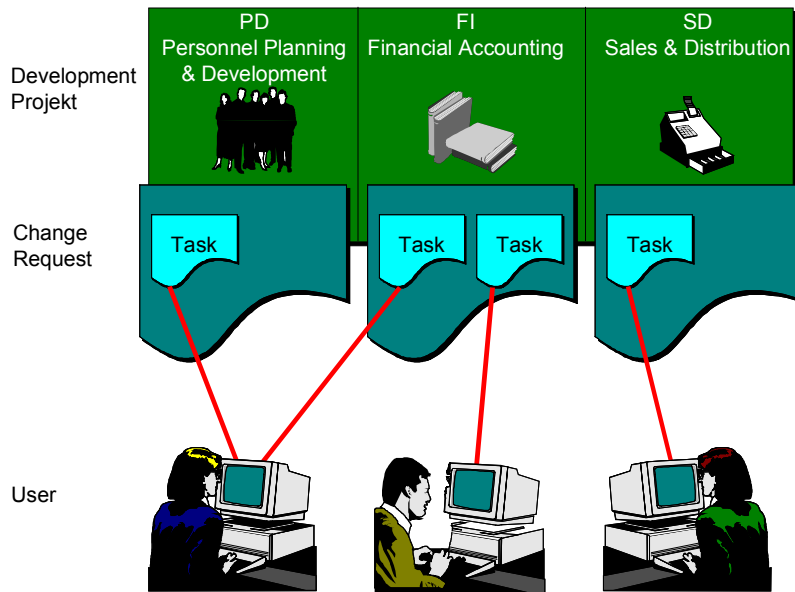

You access the Transport Organizer from a [request overview \[Page 54\]](#) that clearly shows all change requests and allows you to display several levels of detail, right down to the object list itself.

Developments, corrections, and repairs are recorded in [tasks \[Ext.\]](#) and transported using [change requests \[Ext.\]](#).

The target system and type of transport are assigned automatically and no longer need to be maintained by the user.

Several users can work together on a project by organizing their development work in tasks. These tasks belong to a common change request.

You can control access to Transport Organizer functions for different user groups by assigning appropriate authorizations.

Once you have included Repository objects in a change request, you can edit them in this request only. This means that until the change request has been **released**, they are locked against development work or maintenance by other developers not working on this change request. These developers are only allowed to display the objects.

This is how the Transport Organizer prevents uncoordinated, parallel changes from being made to objects. Only make changes to the [original \[Ext.\]](#) objects. A warning appears if you try and change a non-original object.

The Transport Organizer is activated automatically every time you edit a Repository object. An object has to be in a change request before a user can create or change it. Entering objects in requests ensures that all changes made in the ABAP Workbench are registered.

Changes to Customizing data are also registered by the Transport Organizer.

A [development class \[Ext.\]](#) and responsible developer are assigned to each Repository object. This development class indicates which area the object belongs to. This enables you to quickly contact a person in connection with any object. The structure of the entire ABAP Workbench is based on development classes which can assist you in starting your work.

Transport Organizer - Concept

The Transport Organizer provides [version management \[Ext.\]](#) for all Repository objects, enabling you to compare or retrieve previous versions of objects. This lets you document or restore versions released before or after a particular change request or development project.

All developers working on a change request are required to write structured **documentation** when releasing their tasks. This states the aims of the project, its status, and any special features it includes. In addition, all changed objects are automatically recorded in the object list of the change request. This information, together with the documentation and version management, ensures that you have complete control over all revisions made in a single or multiple computer configuration.

Development projects are not worked on in a **production system**, but in one or more **development systems** depending on their size. To ensure that objects remain consistent, each Repository object has a defined original location. Changes are generally made at the original location to prevent unintentional, parallel work on the same object. The original location of Repository objects can be changed with [relocation transports \[Page 48\]](#).

If several development systems are being used, it may be necessary to transport objects specifically to SAP Systems that are not supplied with regular change transports. If necessary, you can also change the transport attributes of the object (original system, development class, transport layer). The transport types required for this are managed by the **extended view of the Transport Organizer**.

To transport Repository and Customizing objects from the development system to other SAP Systems in the system group, transport routes are used, which are defined when the system group is configured in the [Transport Management System \[Ext.\]](#). The transport involves exporting objects from the source system in which the objects were changed and importing them into one or more target systems.

A **transport log** is created automatically for each change request. If errors occur in the production system after an import has taken place from a quality assurance system, the log enables you to immediately find out the following:

- Which objects were transported
- Who requested the transport
- Why the transport was performed

There are [Transport Organizer tools \[Ext.\]](#) available for searching for, displaying, editing, and analyzing change requests and transports.

Transport Management System - Concept

Transport Management System - Concept

You use the Transport Management System (TMS) to model and manage your system landscape. It provides tools for configuring your system landscape, as well as for organizing, carrying out and monitoring transports.

Configuration of a System Landscape

All SAP Systems that are subject to the administration of the TMS form a [transport domain \[Ext.\]](#). This is usually all SAP Systems in the [system landscape \[Page 12\]](#). Certain system settings are the same for all systems within a transport domain, such as the [transport routes \[Page 22\]](#). To achieve this, one SAP System in the transport domain has the reference configuration, with all other SAP Systems in the transport domain taking copies of this reference configuration. The system with the reference configuration is known as the [Transport Domain Controller \[Ext.\]](#); only in this system can you make changes to the reference configuration. Each time you change the reference configuration, you must distribute the new configuration to all systems. The TMS automatically generates RFC connections between the systems in a domain so that they can communicate.

When you install an SAP System, a [transport directory \[Ext.\]](#) is set up for it. The CTS uses this directory to store transport data. In most cases, all SAP Systems in a transport domain have a common transport directory. However, there are situations where this is not possible, for example:

- A system has a 'slow' connection to the network
- The high security level of some systems does not allow file system access by other systems (NFS or shares)
- Different hardware platforms are used

TMS supports multiple transport directories within a transport domain. The systems that share a common transport directory form a [transport group \[Ext.\]](#). Data is exchanged between the systems using the RFC connections of the TMS.

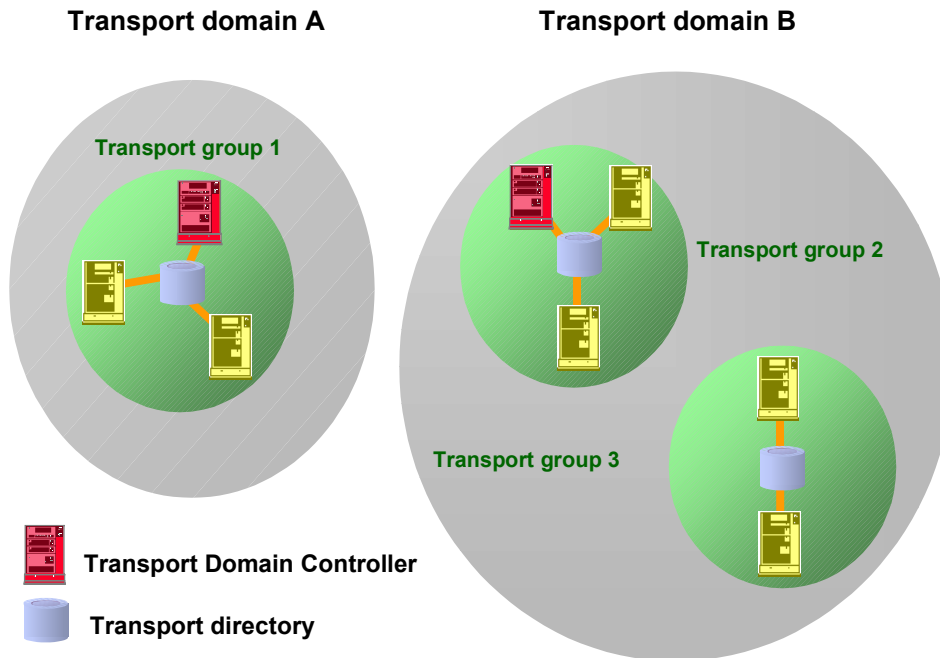

Transport domain A: This transport domain has one transport group. This means that all the systems access a common transport directory.

Transport domain B: This transport domain has several transport groups, each of which shares a transport directory.



All systems in Europe share a transport directory; this is transport group 2. All systems in Asia share a transport directory; this is transport group 3. Together, transport groups 2 and 3 form a transport domain (transport domain B).

When you configure an SAP system landscape, it is usually the case that not all SAP Systems are available right from the beginning. The TMS allows you to define placeholders, or virtual systems. These take the place of systems that you want to include in the landscape at a later date. In this way, you can model the complete system landscape and make the settings for the CTS as soon as you have configured the TMS in one system. The virtual system is replaced when you install the real system.

If you administrate your SAP Systems locally in different locations, for example at head office and in different branches, it may be a good idea to configure several different domains. If you want to make transports between systems in different domains, you can use [domain links \[Ext.\]](#) to link the two domains. The data is transported between the domains using the RFC connections of the TMS, in the same way as transports are made between different transport groups.

If there is no permanent network connection between systems in different domains, you can use [external systems \[Ext.\]](#) in the TMS to make the transports instead. The transport data is exchanged using a transport directory that can be accessed by both domains, or by using a data volume. External systems offer fewer functions than domain links; for example, transport logs in a different domain can only be displayed using domain links.

Transport Management System - Concept

When you configure your system landscape, you first have to configure the transport domain. Only then can you configure the transport routes. For more information, see [Configuring TMS \[Ext.\]](#).

Making Transports

You can use the Transport Management System to organize, carry out and monitor your transports. You no longer need to execute [tp commands \[Ext.\]](#) at the operating system level. You can start and monitor all imports from every system in the transport domain. The TMS uses the RFC connections that were created automatically when the transport domain was configured to display all information on the requests that are waiting for import.

When you make an import, the TMS starts the [transport control program tp \[Ext.\]](#) in the target system. This program imports the data that was earlier exported from the database of the source system. If the two systems do not have a common transport directory, the TMS copies the necessary files into the transport directory of the target system before the import.

If you want to schedule an import for a particular point in time, the TMS schedules a background job in the target system. This is then executed at the time you chose.

If the import accesses another system in the domain, you need to authorize yourself in this system. Even if there is a test system in your domain with free authorization for all users, imports into the production system can only be made by users with special authorizations.

After you start or schedule an import, you can monitor the process from each system in the domain. All imports are logged, so that you can see which transport requests were imported into a system at which time.

For more information, see [Performing Transports \[Ext.\]](#).

Basics of Transport Control

This section suggests ways to organize development projects in a distributed environment, using the Change and Transport System (CTS).

The CTS enables you to organize development projects in complex distributed system landscapes.

For example, you can do the following:

- Transport and freeze completed development work and automatically distribute it to several production, test, training, or development systems.
- Distribute development projects among different SAP Systems on the basis of development classes.
- Transfer critical development work to separate SAP Systems.

If you do not want to organize your own development projects using different systems, then you do not need all the functions provided by the CTS. In this case, you can set up a simple distributed environment consisting of two systems (development and production system) or three systems (development, quality assurance, and production system).

Transport Layers and Transport Routes

Transport Layers and Transport Routes

All development projects developed in the same SAP System and transported on the same transport routes are grouped together to form a [transport layer \[Ext.\]](#).

Before you start the first development project, you create a transport layer in the TMS [transport route editor \[Ext.\]](#). This transport layer is assigned to the development system as its [standard transport layer \[Ext.\]](#). Objects delivered by SAP belong to the transport layer "SAP". Other transport layers are generally only needed when new development systems are included in the system group.

After you have set up the transport layer you set up the **transport routes**. There are two types of transport routes. First you set up [consolidation routes \[Ext.\]](#), and then you set up [delivery routes \[Ext.\]](#):

1. Consolidation routes

To make your changes transportable, set up a consolidation route for each transport layer. Specify your development system as the starting point (source) of these consolidation routes. Specify the quality assurance system as the transport target (in a two-system landscape, specify the production system as the transport target).

Any modified objects that have a consolidation route set up for their transport layer are included in transportable change requests. After the request has been released the objects can be imported into the consolidation system.

If you make changes to objects which have no consolidation route defined for their transport layer, then the changes are made automatically in local change requests (or in Customizing requests without a transport target). You cannot transport them into other SAP Systems.

You can set up one consolidation route only for each SAP System and transport layer.



When you define consolidation routes, note the additional functions available when you use [Extended Transport Control \[Page 25\]](#).

2. Delivery routes

After you have imported your development work into the quality assurance system, you then want to transport it into your production system. You may even want to transport it into several SAP Systems (for example, additional training systems). To do this, you have to set up delivery routes.

Delivery routes have a source system and a target system.

When you set up a delivery route, you are making sure that all change requests that are imported into the route's source system are automatically flagged for import into the route's target system.

You can set up several delivery routes with the same source system and different target systems (parallel forwarding). You can also set up delivery routes in sequence (multilevel forwarding).

CTS transport control makes sure that all requests from the development system are flagged for import into all other SAP Systems in the same order in which they were exported. This is important, since different requests can contain the same Repository object or the same

Transport Layers and Transport Routes

Customizing setting at different development levels, and you must avoid overwriting a more recent version with an older version.

Multilevel Delivery

Here you can activate multiple delivery routes in sequence. You can choose any SAP Systems in the system group as the source systems of the delivery routes; they do not have to be consolidation systems. This allows you to implement complex chains of transport routes.

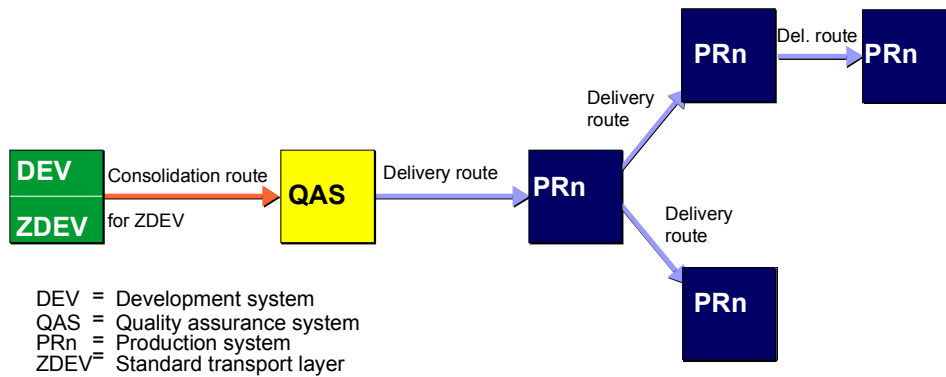

Multilevel delivery is not required in a two- or three-system group. In more complex system landscapes, particularly in layered development projects that have each other as sources, multilevel delivery may prove to be a suitable solution:

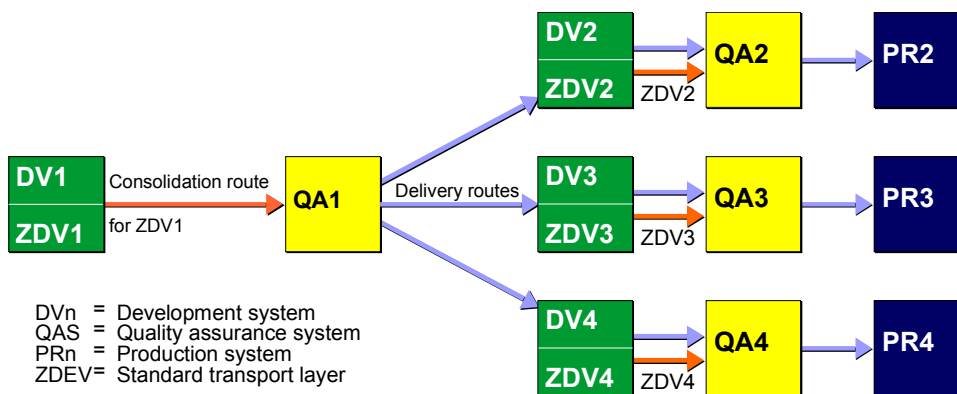

If there are SAP Systems in the [system group \[Ext.\]](#) with releases prior to 4.0, you can only use multilevel delivery under particular conditions. The Transport Management System checks these conditions when you [configure the transport routes \[Ext.\]](#) in a mixed system group.

Assignment of Development Projects to Transport Layers

Assignment of Development Projects to Transport Layers

At the start of a development project, [development classes \[Ext.\]](#) are created for the Repository objects that are to be created as part of the project. When you create the development class you assign it to a transport layer. The SAP System proposes the standard transport layer. All Repository objects that you later create in this development class belong to the transport layer of this development class and are transported according to the routes set up for this layer.

Customizing settings are generally not Repository objects listed in the [object directory \[Ext.\]](#) and do not belong to a development class. This means that you cannot assign them directly to a transport layer.

Customizing settings are always assigned to the standard transport layer of the SAP System in which they are valid (or of the client, if extended transport control is activated). They are then transported from this system (or client) according to the transport routes set up for the standard transport layer.

Repository objects of the SAP standard delivered by SAP or from SAP add-on components installed in your SAP Systems always belong to the pre-installed "SAP" transport layer. You cannot assign these objects to one of your own transport layers. If you want to patch or modify SAP standard objects in your development system, SAP recommends transporting these changes along the same routes as for your own developments. To do this, you need to set up the same consolidation route for the "SAP" layer as for the standard transport layer of the development system; this means that the source and destination of the two consolidation routes must be the same. (For more information, see [Changing the SAP Standard \[Ext.\]](#).) When a two- or three-system group is configured automatically, this consolidation route is created for the "SAP" layer.

The following graphic shows the transport routes of an automatically configured three-system group:

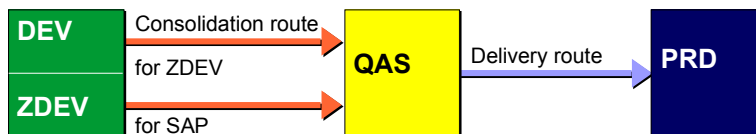

DEV = Development system
 QAS = Quality assurance system
 PRD = Production system
 ZDEV = Standard transport layer
 SAP = SAP transport layer

Extended Transport Control

Use

Extended transport control has the following functions:

- As well as specifying an SAP System as the transport target of a consolidation or delivery route, you can also specify a client. This means that you can configure the transport of client-specific objects just as securely as the transport of cross-client objects.
- You can set the standard transport layer that you use to define the transport target of Customizing requests, among other things, as client-specific.
- You can set up several parallel consolidation targets in target groups. This is often required by ALE.

Extended transport control makes daily transport tasks easier, and it increases security. It also reduces the need for communication between project leaders and system administrators, since the transport routes can now be configured completely. No additional details about the target client need to be given at the time of import.

Features

You can make use of the following extended functions when you configure transport routes in Transport Management.

- Client-specific standard transport layer

When you create Customizing requests, the default transport target of the requests is determined by the standard transport layer. When you use extended transport control, you can set a different standard transport layer for individual clients from that set in the SAP System. This means that you can forward Customizing requests from different clients into different transport targets.

The client-specific standard transport layer is also the default transport layer for new development classes that have been created in a client. If you accept this default, then the cross-client objects that have been created in cross-client Customizing are transported along the same route as the corresponding client-specific Customizing.
- Client-specific transport targets

The transport targets of consolidation and delivery routes do not just specify a system, they also specify a client. Client-specific transport targets are entered in the form:
`<system_name> <client>` (for example, `QAS.013`).
- Target groups

Target groups combine several client-specific transport targets under a symbolic name. You can specify target groups when you define consolidation and delivery routes.

To differentiate them from traditional transport targets you must start and end the names with “/” (for example, `/EUROPE01/`).

When you release a request which has a transport group as a transport target, then the request is flagged for import into every individual transport target
`<system_name>.<client>` in the group.
- Client-specific consolidation routes

Extended Transport Control

Consolidation routes determine (for each transport layer) where changes made in the SAP System are transported after the request has been released.

If you have activated extended transport control, then the transport target can be a particular client in a target system or target group.

If you do not activate extended transport control, you can specify systems only as consolidation targets. This means that the transport administrator has to specify the correct target client at the time of import.

- Client-specific delivery routes

Delivery routes determine whether change requests are to be flagged for import into subsequent systems/clients, after they have been imported into a system.

If you have activated extended transport control, then you can set the delivery routes as client-specific. This makes it possible to supply several clients in one system in sequence.

You can also specify a target group as the target of a delivery route.

- Improved import controls

If you work with extended transport control, you can import requests into different clients in a system without using [unconditional modes \[Ext.\]](#).

When you first import a request into a system, all the objects are imported completely. Any subsequent imports into other clients in the system only import client-specific components.

This makes it possible to set up consolidation routes and delivery routes between different clients in the same system.

Example

The following graphic shows an example of two production systems, PR1 and PR2, linked by ALE. Both of the production systems are preceded by a QA system (Quality Assurance System). The two QA systems are also linked by ALE.



The example merely portrays the options available with extended transport control. It is not a recommendation for setting up your own system landscape.

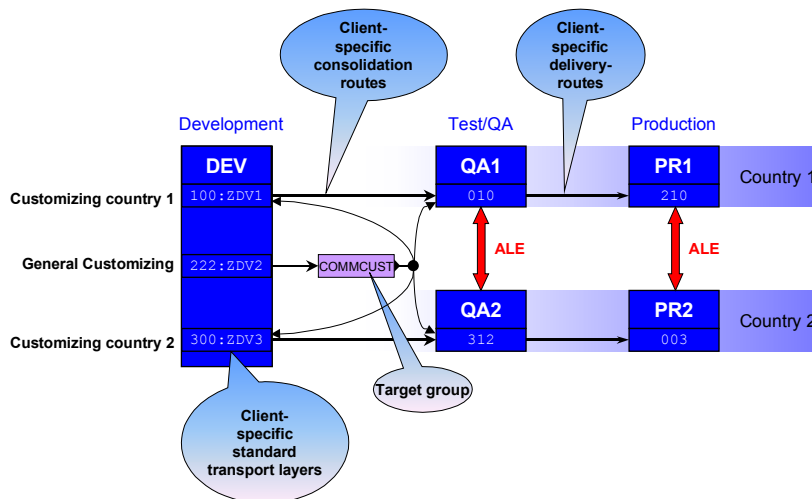

Development takes place in three clients in the system DEV.

- Development, client-specific Customizing and general Customizing take place in client 222, and are released with transport target `/COMMCUST/`. The target group `/COMMCUST/` contains four elementary transport targets:

- QA1, client 010
- QA2, client 312
- System DEV, client 100
- System DEV, client 300

The latter two transport targets are the development clients for country-specific settings. Requests with the transport target `/COMMCUST/` are flagged automatically for import into all four targets.

Alternatively, you can specify just the targets “system DEV, client 100” and “system DEV, client 300” in the target group `/COMMCUST/`, and set up a delivery from “system DEV, client 100” to “QA1, client 010” and a delivery from “system DEV, client 300” to “QA2, client 312”. This defers the imports into the QA systems.

In both cases, the ALE functions remain stable, since both QA-PRD routes are being supplied in parallel.

- Country-specific settings are made in the clients 100 and 300 of the system DEV. They are then released directly to the corresponding country QA systems (the target client is specified). This is done with a client-specific standard transport layer.

The QA systems automatically deliver to the correct target clients in the production systems, since the target client is specified when the delivery routes are defined.

Extended Transport Control

Activities

Transport route configurations are activated according to an 'all or nothing' rule; either the parameter is set in all systems connected by transport routes, and these systems only use transport routes with specified target clients, or the parameter is deactivated for all systems, and only target systems are specified.

You can, however, configure two separate system groups, only one of which uses extended transport control.

Background:

The buffer format that has been used until now does not include target clients (buffers are the operating system files in which the transport requests are flagged for import).

Extended transport control introduces a new format for the buffer lines. This format has, among other things, space for the target client.

For security, versions of the transport control program tp that do not recognize this new format are not permitted to process the new buffers. An appropriate entry in the transport profile prevents this in the system.

Transport Strategy in the CTS

The Change and Transport System provides a range of functions that help you to choose a transport strategy optimally suited to your requirements. We recommend that you follow the transport strategy while you plan and set up your system landscape.

The transport strategy may change during an SAP implementation project, depending which phase of the project you are in.



All users working as developers must know the transport strategy and stick to certain guidelines.

Client Landscape and Transport Routes

Before you start an SAP project, you must decide which [clients \[Page 10\]](#) and systems you need. Then decide which parts of the project are to be developed in which clients, and into which clients you want to transport your changes. To transport your changes, create [transport routes \[Page 22\]](#) between clients or systems.



You must always use transport routes, regardless of which transport strategy you choose.

You can define client-specific transport routes by using [Extended Transport Control \[Page 25\]](#).

Transport Schedules

If different developers work on the same project, dependencies may arise between the objects that belong to the project. So that developments are consistent in other systems, all the changes made by the developers must be transported at the same time. Otherwise, you may cause inconsistencies; for example, if a developer creates a table that references a data element created by another developer. If the change request that contains the table is then imported into a target system in which the data element does not exist, the import will encounter errors.

One way of keeping these dependencies under control is to have a fixed transport schedule, in which all changes released up until a certain fixed date are transported into a client or SAP System.

This method is particularly suitable for the early phases of an SAP project when many changes are being made to the system. A transport schedule in a system landscape with a development system, quality assurance system and production system could be as follows:

- All changes are imported once an hour into the quality assurance system.
- All requests are imported once a week into the planned production system.

This schedule lets the developers test their changes almost immediately in the QA system, and correct any errors. The developers' aim is to consolidate their changes in the QA system before they are due to be imported into the production system. Business processes can be tested in the production system, and it may also be used for holding training courses. Periodic transports of all changes made to the system reduces the work of the system administrator, and keeps your systems synchronized.

For more information, see [Transports with Import Queues \[Page 31\]](#).

Transport Strategy in the CTS

Projects

If you are working on several different development projects at the same time, you cannot always estimate which of the projects will go live at which time. If your development projects do not overlap, or only overlap a little, you can use [projects to control your transports \[Page 40\]](#), and then use different transport schedules for different projects. For example, if a component is just about to go live, you may need to import one project into the production system particularly frequently, with other projects only being imported into the QA system first, and into the production system later.

Quality Assurance

If you work with [mass transports \[Page 33\]](#), all requests released by the developers are imported into production systems. You can implement the [TMS Quality Assurance \[Page 41\]](#) procedure to prevent unchecked changes from being transported. The procedure makes sure that each change request is approved before it is imported into the production system.



You should use the TMS Quality Assurance procedure even if you are using single transports.

Single Imports

If you want to maintain a production system with specific transports, it is best to import single requests rather than importing all changes waiting for import. Use [single transports \[Page 35\]](#) if you have fewer changes to transport and your organization prevents you from having a fixed transport schedule. This method usually entails extra work for the administrators compared to periodic imports. Developers need to pay extra attention to the consistency of their change requests, since the Change and Transport System does not offer as much support in this area.

If a small number of developers are working on a project, or if the developers work very closely with the administrator, they often make their own single transports.

Transport Workflow

You want to make specific single transports into your systems, but would rather have this done by the system administrator, we recommend that you use the [transport workflow \[Page 37\]](#). This method automatically triggers a workflow when you release a change request. The workflow ensures close communication between development and administration.



When using the transport workflow, the administrator can react quickly to any requests from the developers and the project team.

Transports with Import Queues

Any changes that your development teams make to Customizing or Repository objects in the development system are **not** automatically transported to the target systems (such as the quality assurance and production systems) when they are released. When a developer releases a change request, it is only placed in the import queue of the target system. This makes it possible to gather changes in the development system in the import queue over a period of time, and then import them together into a target system (such as the quality assurance system). The request import places the requests in the import queues of the target systems (such as production and training systems). You can make exports and imports into different target systems at different times and with different frequencies.



This allows you, for example, to import a fully tested version of your new developments into your production systems at a time you previously announced to all users.

Import queues can be used as a transition between development and administration. All changes released by developers can be seen immediately by the administrator in the queues. The [Transport Management System \[Ext.\]](#) provides easy-to-use functions for displaying and editing the import queues.

Import queues are a particularly good way of automating transports in your system landscape. They can significantly reduce the amount of work for system administrators responsible for a large number of transports; automation reduces the administrator tasks mainly to monitoring and troubleshooting.

You can choose between two procedures when you use import queues to perform imports:

- You can import [mass transports \[Page 33\]](#) into your systems. This procedure imports all requests waiting for import in the queue. All requests are imported into the target systems in the order they were exported. This minimizes the risk of errors in the target systems caused by requests being imported in the wrong order, and the risk of objects being missing in the target system.



Mass imports are particularly well suited for the quality assurance system and production systems in the implementation phase of a project.

- You can import [single transports \[Page 35\]](#) into your systems. This procedure makes a selection of requests from the import queue and imports them into the target system. The other requests remain in the import queue, where you can choose to import them later, or not at all. Single imports are the most flexible method, however, they demand more administration.



Single imports are particularly well suited for updating and correcting production systems.

Regardless of whether you choose to import mass imports or single imports into your production systems, we recommend that you use [TMS Quality Assurance \[Page 41\]](#) to protect these systems.

Transports with Import Queues

Mass Transports

Purpose

Mass transports are a good solution if you have a large number of transports to administrate and want to automate the process as much as possible.

- The continuous use of mass transports is the most secure way of keeping your system synchronized and consistent.
- Before you import mass imports into your production systems, you must check all requests in the quality assurance system and confirm their transport into other systems. Use the [TMS Quality Assurance \[Page 41\]](#) procedure when doing this.
- If you only want to import some of your development projects into your production systems, [use the projects to control the transports \[Page 40\]](#). You can then pick and choose the requests you want to transport by project.

Features

The CTS offers the following functions for using mass imports in your system landscape:

- When you release requests in the Transport Organizer, the requests are automatically placed in the import queue of the target system (usually the quality assurance system).
- You can display the import queues in TMS, and then schedule or start the imports.
- You can use the import monitor to check any imports that are running.
- All completed import steps are recorded by the system. You can then display them in the import history.
- TMS registers transport errors as alerts, which you can then display and analyze in the CCMS Alert Monitor.

Process Flow

Queue-controlled mass transports are based on the following process flow:

Configure [transport routes \[Page 22\]](#) between your development, quality assurance and production clients.



If you mainly develop Customizing and work with multiple clients in one SAP System, use [Extended Transport Control \[Page 25\]](#) to define transport routes between clients more exactly.

You also need to define mass imports as the import method for the relevant systems. To do this, choose the [transport strategy \[Ext.\] Queue-controlled mass imports](#).

You can also choose to activate the [TMS quality assurance procedure \[Page 41\]](#) to protect your production systems.

Specify the **dates** on which you want to make transports into the different clients in your system landscape. Announce these dates and times to all users; for example, developers need to know when transports are made into the production system so that they can check whether the relevant functions are in the QA system beforehand.

Mass Transports

The administrator can schedule the imports periodically in TMS, or start each import manually.

Only import single change requests (**single imports**) before others in the queue in special cases. Change requests that are imported in advance by the TMS are imported again in the regular import. You can use the [transport workflow \[Page 37\]](#) to import single imports in advance.

Only delete requests from the import queue in special cases; this applies particularly to the import queue of the production system. Otherwise, the consistency of the systems cannot be guaranteed, resulting in serious problems for development, test and support. If a change request contains objects with errors, then you must correct these errors in the development system. You need to import the change request with the corrected object together with the faulty requests. The correct import sequence makes sure that the corrected version is used.

Single Transports

Purpose

You may want to use single transports for the following reasons:

- You only make transports infrequently.
- Your organization does not include fixed import times.
- You want to maintain production systems directly with corrections.

A strategy of single transports has the following risks:

- Increased administration



If you import single requests from the import queue into the target system, you must yourself make sure that the objects in the requests are complete and consistent.

Unlike the [import of individual projects \[Ext.\]](#), the system does not provide automatic support for dealing with relationships between requests.

- Relationships between transport requests can create inconsistencies in the target system:

- Import sequence

It is important that you import requests in the correct order, so that development work is up-to-date in the target system.

- Incompleteness



A request is not imported, but it contains an important data element. You use another request to transport a table that references this data element. Since the referenced data element does not exist in the target system, activation errors will occur when you import the second request.

Process Flow

The single transport strategy is defined as follows:

- Use of transport routes

Change requests are transported using predefined consolidation and delivery routes (see: [Configuring Transport Routes \[Ext.\]](#)).

- Import individual change requests from the [import queue \[Ext.\]](#):

Select the change requests that you want to transport and then import them into the target system. The requests are imported in the order in which they are placed in the import queue.

- Import all change requests of a [project \[Page 40\]](#):

If you want to organize your developments in different projects, use the IMG project functions. If you do this, it is important that you keep your development projects distinct from each other. You can then import your requests in projects.

Single Transports

For more information, see [Choosing a Transport Strategy \[Ext.\]](#).

Transport Workflow

Purpose

The transport workflow provides a framework for transporting enhancements or new developments of existing business functions in a system landscape. It provides a direct connection between development and transport administration. The transport workflow manages the transport process, determines the user for each individual step automatically, and then displays an interface which they can use to perform the task directly.

It is an efficient method of transporting a selected number of requests into a group of transport targets, and uses clearly defined approval steps to ensure the quality of your target systems. The requests can be transportable change requests, Customizing requests, relocation transports or transports of copies. The transport targets do not need to be located on defined transport routes. However, the transport workflow can involve some risks, caused by the dependencies between transport requests:

- Import sequence

It is important that you import requests in the correct order, so that development work is up-to-date in the target system.

- Incompleteness

It is important that the functions transported in the [transport proposal \[Ext.\]](#) are complete; otherwise errors may occur in the import system.



A request is not imported, but it contains an important data element. You use another request to transport a table that references this data element. Since the referenced data element does not exist in the target system, activation errors will occur when you import the second request.

The transport workflow is a generic workflow. Its ability to process the transport route configuration in TMS enables it to adapt itself to any system landscape. This means you can transport multiple requests into multiple targets, even if these targets are not located on the transport routes.

This reduces the amount of work for the transport administrator significantly, and also reduces the number of possible errors in the transport process.

You can use the transport workflow in two different ways.

- Transport workflow as a transport strategy

If you have production systems in your landscape that can only accept approved transports, we recommend that you use the transport workflow to organize and coordinate the transport process.

To do this, set *Workflow-controlled transports* as your [transport strategy \[Ext.\]](#) and configure the [transport workflow \[Ext.\]](#).

Transport Workflow



When you release a transport request, the transport workflow starts automatically and the screen *Create Transport Proposal* appears. The requests are then released implicitly when the [transport proposal \[Ext.\]](#) is sent to the transport administrator.

- Special transport workflow (mass transports)

You can use the special transport workflow to make transports that do not follow the defined transport routes or that take place outside the normal transport schedule (part of the mass transport strategy). These transports may be corrections made in the development system that have to be transported into the production system without delay.

To use the special transport workflow, set *Mass transports* as your [transport strategy \[Ext.\]](#) and configure the [transport workflow \[Ext.\]](#).

Prerequisites

- You have [configured the transport workflow \[Ext.\]](#) for your system.
- The users involved in the transport workflow have a user in the [Workflow Engine \[Ext.\]](#) system/client.
- One or more users have transport administration [authorization \[Page 66\]](#).

Process Flow

The developer creates a [transport proposal \[Ext.\]](#) in the Transport Organizer. This proposal contains the required transport requests. The transport proposal then appears in the [TMS worklist \[Ext.\]](#) of the transport administrator. The administrator can then [approve or reject the transport proposal \[Ext.\]](#). The transport administrator can also make changes to the transport proposal, for example change its contents and the transport target.

After a transport proposal has been approved, the TMS imports the transport requests automatically into the specified target systems. If the proposal is rejected, it is sent back to the [transport proposal inbox \[Ext.\]](#) for [revision \[Ext.\]](#) by the responsible developer. If the import is successful, the proposal is sent back to the transport proposal inbox to be [confirmed \[Ext.\]](#) by the creator of the proposal. The developer can complete the proposal by confirming it, or apply to have it transported into other systems.

We recommend that you only use the transport workflow to transport into those target systems defined by the direct transport routes. Only in the next step should you work out which are the next direct target systems, and then apply to transport into them. This is the best way to keep the transport landscape consistent and complete.

The transport workflow writes an action log for each transport proposal. This log contains all development and transport activities, allowing you to check on the entire process.

Developers and transport administrators can communicate directly by writing notes.

For more information on transport administration, see [Transport Workflow \(Administration\) \[Ext.\]](#).

For more information on the development team, see [Transport Workflow \(Development\) \[Ext.\]](#).

Using Projects to Control Transports

Using Projects to Control Transports

If you work with [IMG Project Management \[Ext.\]](#) then you can use transport control to plan your development work and Customizing activities in structured projects. You can structure changes independently of each other in different projects, and then import them independently into target systems. We recommend that you do this if, for example, you want to go live with different projects at different times, or if you want to link development work in a single area.

If you go to the corresponding IMG nodes of an IMG project you can only make changes in requests that are assigned to the project. The project to which a change request belongs is displayed in the import queue. This means that you can make [imports \[Ext.\]](#) into target systems project-by-project.

It is important that you make sure that projects are free from dependencies while you plan them.

It is important that you make sure that projects are free from dependencies while you plan them. However, the Change and Transport System does support small overlaps between projects. If your projects do overlap, then you must define [dependency relationships \[Ext.\]](#) between the objects that belong to different projects but contain some of the same objects. These relationships need to be defined to ensure that imports are made in the correct order.

In certain situations, project administrators need to restrict what work can be done in a project. They can control this with the [project status switch \[Ext.\]](#).

For more information, see [Transport Strategy in the CTS \[Page 29\]](#) and [Working with Projects \[Ext.\]](#).

TMS Quality Assurance

Use

TMS Quality Assurance increases the quality and the availability of the production systems by letting you check requests in the QA system before they are delivered to subsequent systems.

The system for which the QA approval procedure is activated is called the **QA system**. When the **QA approval procedure** is activated, transport requests are only forwarded to the delivery systems if all the QA approval steps are processed for each request in the QA system and each request has been approved. (When you configure the QA system, you determine how many QA approval steps have to be processed for each request.) If a check for an approval step is not successful, the entire request cannot be approved.



Rejected requests are **not** imported into the delivery systems of the QA system.



If you reject requests, there is the risk that errors may occur when they are imported into the delivery systems. This is a result of the requests containing objects that are referenced from other requests. It is safer to correct an error using a subsequent transport (see [Transport Strategy in the CTS \[Page 29\]](#)).

Integration

In the TMS transport route configuration, you determine which system is the QA system, and which approval steps should apply to this system. You configure the QA approval procedure by performing these two steps. All the requests that are then imported into the QA system are included in the QA worklist.

You can go from the TMS Import Overview to the QA Worklist where you have to check the requests for each approval step.

You can only import all requests into the delivery systems if all the requests ready for import have been checked (which means approved or rejected).

If all the requests for a project and target clients are checked, you can import them even if requests for other projects and target clients have not been checked yet.

Prerequisites

Your system landscape contains at least one QA system from which there are configured delivery routes into other systems.



In a 3-system landscape, the requests from the development system are imported into the QA system. There, the requests are checked and the approved requests are forwarded to the production system.

Functions

- Configuring the QA approval procedure (determining the QA system and the approval steps)

TMS Quality Assurance

You determine which system is the QA system, switch on the option *Forward after confirmation* for this system, and define which approval steps are valid for this system.

- Processing the QA worklist

After a system has been configured as the QA system, the QA worklist is built. You then have to check the requests in these views for the individual approval steps.

- Displaying the QA history

Using this history you can display the QA activities for a specific period.

Activities

1. When you configure the [QA approval procedure \[Ext.\]](#), you determine the QA system, switch on the option *Forward after confirmation*, and define the approval steps for that system.
2. You [approve or reject requests \[Ext.\]](#).
3. You display the [QA history \[Ext.\]](#) for a selected period.

Transactions and Tools in the CTS

The Change and Transport System (CTS) provides you with tools for recording the changes you make to Repository objects and Customizing objects, and for distributing these changes within the system landscape. The CTS offers the team members of a software development or implementation project transactions in the SAP System and programs at the operating system level.

The [Transport Organizer \[Page 44\]](#) provides functions for creating, documenting and releasing change requests during the Customizing and development process. The Transport Organizer is designed specifically for use by the development team and the project managers of a development or implementation project.

The [Transport Management System \[Page 59\]](#) (TMS) supports administrators in organizing, performing and monitoring imports. The TMS also helps you to set up your system landscape, particularly the configuration of the transport routes.

The [transport tools \[Ext.\]](#) `tp` and `r3trans` are programs at the operating system level. They do not usually have to be executed by the user directly since they are called automatically by the CTS. The transport tools communicate with the SAP System and the database, and export and import requests.

Transport Organizer

Transport Organizer

The [Transport Organizer \[Ext.\]](#) provides functions for creating, documenting and releasing change requests during the Customizing and development process, and for reorganizing your development landscape. The Transport Organizer tools are designed specifically for use by the development teams and the project managers of a development or implementation project.

The [extended view of the Transport Organizer \[Page 50\]](#) is intended for more specialized tasks.

Functions in the Transport Organizer

You call the initial screen of the **Transport Organizer** with Transaction SE09 or SE10. You can also access the request overview of the Transport Organizer from all ABAP Workbench transactions by choosing *Environment* → *Transport Organizer (Requests)*.

The *Display* function lets you search for all requests that belong to the specified user and match the standard selection criteria set. You can change the standard selection as required.

The status selection for requests is used by default for the task selection. However, you can change this by going to the initial screen and choosing *Settings* → *Other settings*.



Tasks that are not assigned to a request can no longer be created. This means that these tasks are no longer displayed as standard. If you still own tasks of this type, use the request search to display them.

The right side of the initial screen shows you cross-system information on the status of [transports and repairs \[Ext.\]](#), and also lets you display the [transport proposal inbox \[Ext.\]](#) of the [transport workflow \[Page 37\]](#).

You can find various tools for searching for, analyzing, and managing change requests by choosing *Goto* → [Transport Organizer tools \[Page 58\]](#).

Change Requests

Change Requests

[Change requests \[Ext.\]](#) are managed by the Transport Organizer. Changes to Repository and Customizing objects are recorded in change requests.

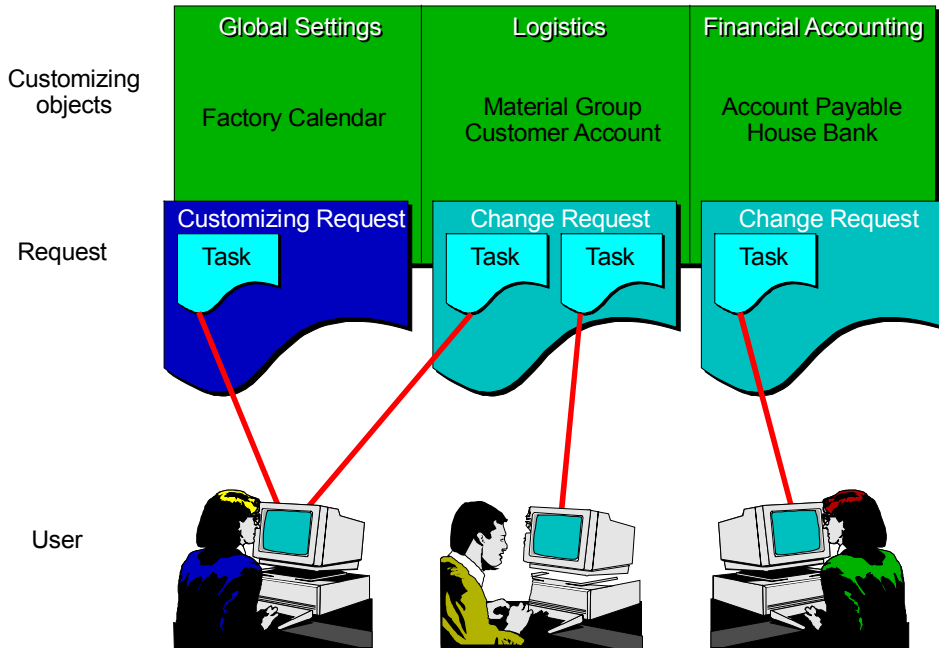

So that you can differentiate between global changes to the system and client-specific Customizing settings, the CTS records your changes in either a Workbench request or a Customizing request:

- [Workbench Requests \[Ext.\]](#)

When you change a Repository object of the ABAP Workbench, a query window appears in which you need to specify a Workbench request. You can only save the changes if you have assigned the object to a change request.

Workbench requests and the tasks assigned to them are normally used to record changes to Repository objects and Customizing for all clients. However, you can also include client-specific Customizing.

Whether the changes to Repository objects are transported depends on whether a transport route is defined from the current SAP System for the development class of these objects. From the system settings, the system automatically determines whether the change requests are transportable and to which target system they should be transported.

- [Customizing requests \[Ext.\]](#)

Customizing requests record client-specific Customizing settings made in a single client (the source client of the request).

Automatic **recording of configuration activities** in the Customizing work for a client can be activated or deactivated for each client with [Client Control \[Ext.\]](#). If automatic

Change Requests

recording is active, a query window appears when you change Customizing settings, asking you to specify a Customizing request.

Whether Customizing requests are transported or not, does **not** depend on the objects entered, as is the case with Workbench change requests. The Customizing requests in an SAP System (or in a client if you use Extended Transport Control) are either all transportable or all local, depending on the **system setting**. The system uses the [standard transport layer \[Ext.\]](#) to determine automatically whether the change requests are transportable and to which target system they should be transported. However, you can change this manually.

See also:

[Configuring Transport Routes \[Ext.\]](#)

[Request Types and Task Types \[Ext.\]](#)

Transports of Copies and Relocations

Transports of Copies and Relocations

- Transports of copies

You can use this request type to transport objects to a specified SAP System.

The objects are transported with the version they have in the current SAP System. The original location of the objects remains unchanged. There is no delivery to another SAP System.

- Relocations **without** development class change

You can use this request type if you want to develop objects in another SAP System **on a temporary basis**. For example, you may want to make special developments in a separate SAP System so as not to interfere with the development process.

A relocation without development class change basically offers the same functions as a transport of copies. This request type allows you to move the original location of objects to the target system.

- Relocations **with** development class change

You can use this request type when you want to change the development system of individual objects **on a permanent basis**.

This request type allows you to change the original location of objects to the target system and change the development class of the objects at the same time.

The development class is changed automatically. If you choose a suitable development class the objects have the right transport attributes immediately after you import them into the target system of the request. Here you can edit them in transportable change requests without needing to make any further settings.

- Relocations of complete development classes (with change of transport layer)

You can use this request type when you want to change the development system of a complete development class **on a permanent basis**.

This request type allows you to automatically change the transport layer of the development class.

To do this, you only need to specify the development class and transport layer to which you want to assign the development class. The object list of the request is set up automatically and contains all objects in the development class.

The transport layer is changed automatically. If you choose a suitable transport layer the objects have the right transport attributes immediately after you import them into the target system of the request. Here you can edit them in transportable change requests without needing to make any further settings.



You have to set up the object list yourself for the first three request types. For information on this, see [Including Objects in a Request Manually \[Ext.\]](#).

You can only enter complete objects in the object list of relocations. If there are sub-objects (for example, from other requests), you can let the system convert them to the corresponding parent objects. To do this, go to the Transport Organizer request

Transports of Copies and Relocations

overview and choose *Request/task* → *Object list* → *Sub-objects* → *Complete objects*.

Transport Organizer (Extended View)

Transport Organizer (Extended View)

You call the initial screen of the **extended view of the Transport Organizer** with Transaction SE01. You can access this transaction from the standard Transport Organizer by choosing *Environment* → *Transport Organizer (extended view)*.

Provided you have configured the system correctly, transportable change requests and Customizing requests automatically ensure that the subsequent systems are supplied consistently with your development work.

Extra transport types are provided in the extended view to meet any special requirements:

- Piece lists
- Client transports
- Delivery transports (SAP/Partner → Customer)
- Individual display

Unlike the Workbench and Customizing requests, there are no automatically assigned transport routes for the transport types described here. Similarly, these requests do not follow configured deliveries.

Since some of these request types have their own naming conventions and you cannot search by owner for all request types, the extended view of the Transport Organizer was designed with five different selection screens.

To display an individual selection screen, choose the appropriate tab page.

You can find various tools for searching for, analyzing, and managing transport requests by choosing *Goto* → [Transport Organizer Tools \[Page 58\]](#).

Piece Lists

You can use this request type to set up your own object lists and save them under a name of your choice.



The first three characters must not be "SAP", the fourth character must not be "K".

You can use these piece lists as a template for the function *Request/task* → *Object list* → *Include objects*. The [Include Objects in Request <Request Number> \[Ext.\]](#) dialog box appears.

Piece lists have the following attributes:

- You cannot release them; this also means that you cannot transport them.
- They have an object directory entry and are therefore assigned to a development class.
They have the same transport attributes as all objects in this development class.
- If you have assigned the piece list to a transportable development class, then when you make changes to the piece list the entry LIMU COMM <piece list name> is made in your current change request.
- After the change request has been imported, the piece list is also in the target system of the request; however, the objects entered in the piece list are not automatically included in the transport.

Client Transports

Client Transports

In Release 4.0, the cross-system client transport was changed to this new transport type. This allows special security precautions to be implemented for such transports. For example, client transports are not included in a normal `tp import all` or `tp put`.

See also:

[Client Copy and Transport \[Ext.\]](#)

Delivery Transports

Use the *Delivery* selection screen to display transports that deliver software changes from SAP or SAP partners to customers.

This selection screen covers the following request types:

- Piece list for upgrade
This transport type imports new releases into your SAP System when you upgrade.
- Piece list for Support Packages
This transport type imports corrections into your SAP System.

Request Overview

Request Overview

You can access the request overview of the Transport Organizer directly from all ABAP Workbench transactions and Customizing transactions with *Utilities* → *Transport Organizer (Requests)*.

You can access the request overview of the extended view of the Transport Organizer from the initial screens of Transaction SE01 by choosing *Display*.

The requests are grouped and displayed under a hierarchy of sort nodes, corresponding to the following request attributes:

- Source system
- Source client
- Transport target
- Request owner
- Request type
- Request status
- Project

In the Transport Organizer, only the levels project, request type and request status are normally active.

If the hierarchy selected by the SAP System does not suit your requirements, you can change the setting as follows:

- Temporary setting
 - By choosing *Edit* → *Sort sequence*, you can add or remove sort levels, or change their hierarchy.
- Permanent setting
 - By choosing *Utilities* → *Settings*, you can choose the following permanent settings:
 - Display short texts of tasks
 - Display change date of requests
 - Sort by request owner

The objects contained in the requests and tasks are displayed below them, sorted by object type. Double-click an object to access the editor for displaying or editing the object.

Functions in the Request Overview

The hierarchical list presents you with a selection of functions that you can apply to the respective elements in the list. To do this, you first have to position the cursor on the relevant element.

Then choose *Request/task* → ...

Other requests	Selection of requests of another user; the selection criteria specified in the initial screen are used.
Request header	Display or change the header data of a request or task
Create	Create a new request [Ext.]
Change owner	Change the owner of a request or task
Release	Release a request or task
Delete	Delete a request or task
Change type	Assign the task attributes: <ul style="list-style-type: none"> • Development/correction • Repairs • Unclassified
Overall check	
Objects (syntax check)	Standard object checks [Ext.] are performed on all objects contained in the request.
Check request consistency	Each object list entry must be syntactically correct. The transport attributes of the objects must correspond to the request attributes.
Requests	
Add user	Add a user to a request. A new task is created for this user.
Protect [Ext.]	Only the owner of the change request can add users to a protected change request.
Remove protection	Remove protection for a change request
Request attributes [Ext.]	Edit the attributes of a change request
Object list	
Display/change object list	Branch to the object list editor
Lock objects [Ext.]	Lock objects entered manually in the object list
Sort and compress	Delete redundant entries that resulted from creating object lists manually
Object directory entries	Display/change the object directory entries of all objects entered in the request

Functions in the Request Overview

Include objects [Ext.]	<p>Include objects in a request. You can choose from the following functions:</p> <ul style="list-style-type: none"> • Include object list from another request • Include object lists from multiple requests; make a selection of requests. • Free object selection; make a selection of objects.
--	---

Choose *Utilities* → ...

Standard requests	
Set	Flag a change request as the standard request. When you have flagged a request as the standard request, it is selected automatically when you edit objects. The request selection dialog does not appear.
Reset	Remove flag that makes a change request the standard request
Validity period	Place a limit on how long a request can be flagged as the standard request. The flag is reset automatically when the validity period is over.
Reorganize	
Reassign task	Reassign a task to another request
Merge requests	Move all objects and tasks to another request. The old (empty) request is then deleted.

You can find out what the colors used in the request overview mean under *Utilities* → *Legend*.

Objects in the Transport Request and IMG Activities

You can store a link between objects in a transport request and the corresponding IMG activity in the transport request. To do this, you must use the IMG to edit the Customizing transaction.

The hierarchical request overview groups together Customizing objects of the IMG activity. Click the IMG activity to edit these objects.

Transport Organizer Tools

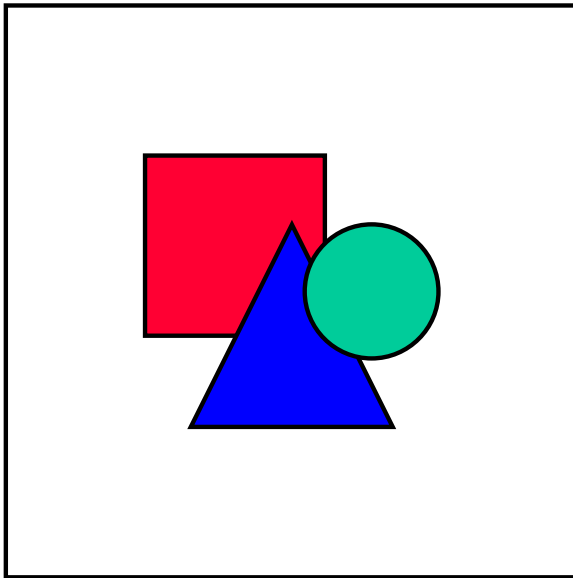

Transport Organizer Tools

In the initial screen of the Transport Organizer, choose *Goto* → *Transport Organizer tools* to display a collection of tools that support your work with the Change and Transport System.

If you are working with administrator authorization in the Change and Transport System (authorization S_CTS_ADMIN), you are allowed to use a wider range of tools.



As an administrator, you can make critical changes to system parameters.

Check the consequences of your changes beforehand.

For a detailed description of the function, click the appropriate tool.

To execute a tool, position the cursor on the tool and choose *Execute*.

For more information on the individual functions, see [Functions of the Transport Organizer Tools \[Ext.\]](#).

Transport Management System (TMS)

The [Transport Organizer \[Page 45\]](#) supports the software development team in its work until the release of a change request. Thereafter, the Transport Management System supports the administration in importing the request into the target systems.

Use the Transport Management System (TMS) to organize, carry out and monitor transports between SAP Systems.

No user actions at the operating system level are required, since all the required information and functions are provided in the SAP System.

The Transport Management System offers the following functions:

- [Configuration of the transport routes with a graphical editor \[Ext.\]](#)
- [Display of the import queue \[Ext.\]](#) for all SAP Systems in the transport domain
- [Import of all requests in the import queue \[Ext.\]](#)
- [Import of all requests in a project \[Ext.\]](#)
- [Import of individual requests \[Ext.\]](#)
- [TMS Quality Assurance \[Page 41\]](#)
- [Transport Workflow \[Page 37\]](#)
- [Special features when using multiple transport directories \[Ext.\]](#)

To start the TMS, call the Transaction STMS.

User Exits in the Change and Transport System

User Exits in the Change and Transport System

Use



You can make use of [user exits \[Ext.\]](#) at the following times:

- before you create a request
- before you export a request
- after you export a request
- after you import a request
- after you change a request owner
- when you set the template for the task documentation
- when you choose the current CTS project.

These user exits are implemented using [Business Add-Ins \[Ext.\]](#). For more information, see the SAP Library under *Basis Components* → *ABAP Workbench* → *BC - Changing the SAP Standard* → [Business Add-Ins \[Ext.\]](#).

Procedure

The CTS Business Add-Ins are listed in the Implementation Guide (IMG) and can be displayed with the *Customizing: Execute Project* transaction.

1. Call Transaction SPRO (*Customizing: Execute Project*).
2. Choose *SAP Reference IMG*.
3. Choose *Basis Components* → *System Administration* → *Change & Transport System* → *Business Add-Ins in Change & Transport System Area*.
4. Choose  to display the documentation on a user exit.
5. Choose  to implement a user exit.

Authorization Concept in the CTS

All functions in the CTS are safeguarded by detailed authorization checks.

With the help of authorizations, you can specify whether a user may perform administration functions and which request types this user can edit.

SAP provides roles for the different CTS user types. Each role has the appropriate authorizations for the different CTS activities. In most cases it is sufficient to set user authorizations by assigning roles. You can use the **role maintenance** transaction (**PF09**) to change the authorizations of roles for your own requirements, or to create new roles.

For more information, see [Roles in the Change and Transport System \[Page 62\]](#).

Roles in the Change and Transport System

Roles in the Change and Transport System

The Change and Transport System offers you the following roles:

- [Transport Administrator \[Page 63\]](#)
- [Transport Operator \[Page 65\]](#)

Transport Administrator

Technical name: SAP_BC_TRANSPORT_ADMINISTRATOR

Tasks

A user with the role *Transport Administrator* is a superuser of the Change and Transport System. The tasks of this user include:

- configuring the system landscape with the Transport Management System
- importing new SAP software
- routine transport tasks such as imports, approving changes, and so on.

The *Transport Administrator* role has all authorizations in the Change and Transport System.

Activities in the Change and Transport System

The main daily task of the *Transport Administrator* is importing transport requests into the systems of his or her transport domain. This includes actually importing the requests, approving transports that are part of the transport workflow or quality assurance procedures, using the Alert Monitor to monitor the transport domain, and tracking imports. The *Transport Administrator* has full authorization to analyze and edit transport requests in the Transport Organizer and the Transport Organizer tools.

The administrator also configures the system landscape for the Change and Transport System, including the transport domain and the transport routes. He or she sets the system and client change options.

The *Transport Administrator* imports new SAP software, such as Support Packages and add-ons, upgrades the system, and adjusts any modifications. Language transports are another area for which this administrator is responsible.

Note

The *Transport Administrator* has the Transactions STMS, SA38 and RZ20 in the LaunchPad, without which certain less frequent functions cannot be accessed. If you change the single role *Transport Administrator* into a composite role, and want to make the LaunchPad less complicated, you can delete these transactions from the composite role menu. This does not change the authorization to execute these transactions.

Integration

Transport requests are created by the [Customizing Project Administrator \[Ext.\]](#) and the *Development Project Leader*. These users create tasks for the [Customizing Project Members \[Ext.\]](#), [ABAP Developers \[Ext.\]](#) and *Documentation Developers* working on the project. In turn, these users record their changes in transport objects in tasks and then release the tasks. After the *Customizing Project Administrator* or the *Development Project Leader* has released it, the request is imported into other systems by the *Transport Operator* or *Transport Administrator*.

The *Transport Administrator* is supported in his or her routine tasks in the Change and Transport System by the *Transport Operator* (making transports, approving changes, monitoring, and so on). However, fundamental changes to the SAP Systems, such as reconfiguring the landscape, importing SAP software, creating transports, deletions, and so on, remain the responsibility of the *Transport Administrator*.

Transport Administrator

One typical task of the *Transport Administrator* is to use the client copy function. All transactions and authorizations for this function are in the role [Client Copy \[Ext.\]](#).

The *Transport Administrator* needs display authorization for the ABAP Workbench to be able to analyze transport objects. This authorization is in the role *ABAP Developer: Display Authorization*.

Transport Operator

Technical name: SAP_BC_TRANSPORT_OPERATOR

Tasks

The *Transport Operator* is responsible for routine tasks such as imports, approving software changes, transports, tracking imports, and so on.

Activities in the Change and Transport System

The tasks of the *Transport Operator* include:

- importing transport requests into systems in the transport domain
- approving transports that are part of the transport workflow or quality assurance procedure
- using the Alert Monitor to monitor the transport domain
- using the import tracking functions to check transports
- analyzing and editing the contents of transport requests.

The *Transport Operator* role has display authorization in the Transport Organizer and Transport Organizer tools.

Integration

Transport requests are created by the [Customizing Project Administrator \[Ext.\]](#) and the *Development Project Leader*. These users create tasks for the [Customizing Project Members \[Ext.\]](#), [ABAP Developers \[Ext.\]](#) and *Documentation Developers* working on the project. In turn, these users record their changes in transport objects in tasks and then release the tasks. After the *Customizing Project Administrator* or the *Development Project Leader* has released it, the request is imported into other systems by the *Transport Operator* or *Transport Administrator*.

The *Transport Operator* supports the *Transport Administrator* in his or her routine tasks in the Change and Transport System (making transports, approving changes, monitoring, and so on). However, fundamental changes to the SAP Systems, such as reconfiguring the landscape, importing SAP software, creating transports, deletions, and so on, remain the responsibility of the *Transport Administrator*.

The *Transport Administrator* needs display authorization for the ABAP Workbench to be able to analyze transport objects. This authorization is in the role *ABAP Developer: Display Authorization*.

Authorizations in the CTS

Authorizations in the CTS



This section is intended for customers with longer experience of the SAP System. If you have just installed the system, use the [role maintenance \[Ext.\]](#) transaction to maintain authorizations.

If you want to set up your own authorizations, bear in mind that in addition to the CTS authorizations, users also require the following authorizations to work with the extended view of the Transport Organizer:

- S_DATASET_AL (for accessing files)
- S_C_FUNCT_AL (for calling external programs)
- S_TCD_ALL (for calling transactions)

Since Release 4.0, the administration functions in the CTO have been safeguarded by a new authorization object called S_CTS_ADMI. The authorization object S_TRANSPRT introduced in 3.0 is now used exclusively to safeguard functions that directly change requests and tasks.



The authorizations are checked independently of the user name. User DDIC therefore does not automatically have administration rights. A user who wants to schedule the transport program (RDDIMPDP) needs administration authorization so that the program can run without errors.

The authorization object S_TRANSPRT consists of the fields *Activity* and *Request type*. The following values are used:

Activity	Description
01	Add or generate
02	Change
03	Display
05	Lock
06	Delete
23	Change/edit object list manually
43	Release
50	Change source client
60	Transport
65	Merge request
75	Release other user's requests
78	Edit transport proposal
90	Change owner

Authorizations in the CTS

Request types	Description
CLCP	Client transports
CUST	Customizing requests
DLOC	Local change requests
DTRA	Transportable change requests
MOVE	Relocation transports
PATC	Support Packages
PIEC	Piece list
TASK	Task (repair or correction)
TRAN	Transports of copies

The authorization object S_CTS_ADMI, with safeguards administration functions, only has the field *CTS_ADMFCT*, whose values describe the various administration activities. Use the following values to assign the user authorization for particular administration functions.

Administration function	Description
TABL	Maintain the control tables of the Transport Organizer (for example, configure the transport routes) <ul style="list-style-type: none"> Schedule the transport dispatcher RDDIMPDP Call certain administration tools (Transaction SE03) Extended maintenance authorization when changing the object directory entries with the tool <i>Change Object Directory Entries of Objects</i> (Transaction SE03).
INIT	Initialize the Transport Organizer, for example, after a system copy
SYSC	Set the system change option
PROJ	Manage projects in the Change and Transport System
INBX	Edit the TMS worklist
QTEA	Approve transports into the production system
IMPA	Import all requests in an import queue
IMPS	Import individual requests into the target system
TADM	Special transport functions in TMS
TDEL	Delete transport requests from the import queue
TADD	Forward transport requests to an import queue
TQAS	Activate or delete inactive transport requests
IMPT	Import requests into the target system using the Transport Management System (obsolete)

Authorizations in the CTS

EPS1	Generate EPS objects
EPS2	Change EPS objects

Authorizations in the Transport Organizer



If you have just installed the system, use the [role maintenance \[Ext.\]](#) transaction to maintain authorizations.

Delivered Profiles and Authorizations

You can use the basis profiles delivered by SAP to assign your users general basis authorizations depending on their areas of responsibility.

The basis profiles are assigned these authorizations as follows:

Profile	User type (global view)	Functions in the CTS
S_A.SYSTEM	System administrator (superuser)	System administrator
S_A.ADMIN	Operator	Display only
S_A.CUSTOMIZ	Customizer	Project manager
S_A.DEVELOP	Developer	Developer
S_A.USER	User	Display only
S_A.SHOW	Basis: Display only	Display only

- **System administrator:** Authorizations S_CTS_TR_ALL, S_CTS_ADMIN



The authorization S_CTS_ADMIN allows you to use functions that have wide-reaching effects (such as *Set system change option* function). Therefore, only assign this authorization to selected employees.

This user has all authorizations within the Transport Organizer, for editing requests (S_CTS_TR_ALL) as well as for the administration functions (S_CTS_ADMIN).

The administration functions include:

- Use of the Transport Organizer tools, which cannot be accessed by a user without administrator authorization.
- Extended maintenance authorization when changing the object directory entries with the tool *Change Object Directory Entries of Objects* (Transaction SE03).
- All TMS functions such as maintaining the system landscape and the transport route configuration.

- **Project manager:** Authorizations S_CTS_PROJEC, S_CTS_PIECLS, S_CTS_EPS and S_CTS_PRPS.

Project managers can perform all actions in the Transport Organizer required for development projects.

Authorizations in the Transport Organizer

Except for client transports, they can create, edit, lock, and release all types of requests.

The authorization S_CTS_PRPS is needed so that the project manager can use [CTS project functions \[Page 40\]](#) when working with IMG Projects.

- **Developer:** Authorizations S_CTS_DEVELO, S_CTS_PIECLS

Developers can only work on developments at task level. They cannot create change requests or tasks and cannot change the owner of a request or task.

When a developer has completed his or her development work, he or she can release the task to the higher-level change request. However, the developer may not release the change request itself.

- **Display authorization:** S_CTS_SHOW

A user with this authorization can only obtain information on change requests and tasks and display corresponding logs.



The authorization concept described above lets you set up groups of users in the following way:

A **project manager** defines a development project. He or she creates a change request for the development work in the Transport Organizer. The project manager can then assign **developers** to this request, who will work on tasks within the change request.

Developers who do not have a task in a change request cannot create or change ABAP Workbench objects.

Project managers can transfer other requests and tasks to themselves with the *Change owner* function. They can also integrate their own change requests in one of their other change requests to combine various development projects (*Merge request* function).

When developers have completed their tasks, they release them to the change request. After all the tasks have been released, the project manager releases and exports the change request.

Authorizations in TMS

Communication between SAP Systems is implemented using RFC connections, which are generated when the Transport Management System (TMS) is configured. Within a transport domain, all the SAP Systems can communicate with each other using RFC.

The following principles apply in the TMS:

- When using TMS, SAP Systems cannot be accessed within the transport domain from an SAP System outside the transport domain.
- For each target system, two RFC connections are used (one for read access and one for change access).
- The authorization check always occurs in the target system.
- You can only change the TMS configuration from the [transport domain controller \[Ext.\]](#).

To prevent unpermitted access to an SAP System, the two generated RFC connections and/or their users are used:

- A connection for **read access** (`TMSADM@<SID>.<transport domain name>`)
 - This connection is used for all read accesses that do not affect sensitive data. The user TMSADM is created in client 000 in each SAP System. This user has the following authorizations only:
 - Read and write authorization for the common transport directory
 - RFC authorization in TMS
 - Display authorization in CTS
 - User TMSADM enables you to distribute the basis configuration to all SAP Systems in the domain on the domain controller and to display the import queue.
- A connection for accesses that cause **changes** in the target system
 - If the authorization for user TMSADM are not sufficient for certain actions, this internal connection always triggers a logon screen in the target system where you must identify yourself with a user name and a password. (You can also change the target client in this logon screen.) This user must be authorized to make changes. This means the user must have greater authorization than that of the automatically created user TMSADM. To do this, give the appropriate [authorizations \[Page 74\]](#).
 - This ensures that the user must log on in the target system with a user name and password as soon as a function is executed that causes a change in the target system (viewable on the [Alert Viewer \[Ext.\]](#)).
 - Because changes to the import queue and to imports are considered to be critical to security, an explicit logon is needed to perform these changes.
 - If you have a large number of SAP Systems to manage, this logon procedure can be time-consuming. To combat this, you can activate [TMS Trusted Services \[Page 73\]](#) or give multiple [authorizations \[Page 74\]](#) to the user TMSADM generated in the SAP System. Change the user TMSADM in the SAP System in which you want to suppress the logon procedure. This is generally not the transport domain controller. This enables multiple accesses via the connection and an explicit logon in the target system is not required for each access.

Authorizations in TMS



If authorizations are extended, it is easier for an anonymous user to make changes to the system.

You can also [reset user TMSADM to the default again \[Ext.\]](#).

The [transport workflow \[Page 37\]](#) uses two generated RFC connections and users, in the same way as the RFC connections above.

- Connection for **read access** (`TMSWF@WORKFLOW_ENGINE`)

This connection is used for all read accesses that do not affect sensitive data. The user TMSADM_WF is created in the Workflow Engine system/client. This user has the following authorizations:

- Read and write authorization for the common transport directory
- RFC authorization in TMS
- Display authorization in CTS
- Count the work items in the inbox

The user TMSADM_WF can create transport proposals in the Workflow Engine, and read transport proposals from the database.

- A connection for accesses that cause **changes** in the target system

If the authorizations of the user TMSADM_WF are not sufficient, the same applies as for the user TMSADM.

Since you can change transport proposals in the transport proposal inbox or [TMS worklist \[Ext.\]](#) only, you must log on to them explicitly.

For security reasons, we do **not** recommend extending the authorizations of the user TMSADM_WF.

You can also [reset user TMSADM WF to the default again \[Ext.\]](#).

TMS Trusted Services

To achieve the correct balance between the twin goals of **data protection** and **usability**, you can choose between different levels of protection and usability in the Transport Management System (TMS).

The standard RFC connection settings in TMS guarantee maximum protection when reading and changing data. If [user TMSADM \[Ext.\]](#), who only has authorization for read access and non-critical changes, remains unmodified, then the user cannot use TMS to obtain uncontrolled access from one system to another. This means that you can manage systems with differing levels of protection in a transport domain without the 'non-secure' systems endangering the 'secure' systems. The downside is that you must log on with user name and password each time you use TMS to access and make changes to the target system.

TMS Trusted Services suppress the logon procedures in the target systems, after you have successfully logged on to a client in one of the systems in the transport domain. All other authorization checks in the TMS are then made on the user name that you used to start the TMS in the source system. This means that the identity of the user is not checked every time you use TMS to access a system, only when the user first logs on to a client in the transport domain. The only check made in the target system is to see whether the user has the correct authorization for the particular action (such as importing a transport request). TMS Trusted Services must only be used if the user names are the same in all clients in all SAP Systems in the transport domain.



This also applies to the test systems in the transport domain. Users who have administration authorization in the test system could obtain unauthorized access to other systems in the transport domain under certain circumstances.

For more information, see [Activating TMS Trusted Services \[Ext.\]](#).

Setting Authorizations for TMS

Setting Authorizations for TMS

Use

As an alternative to the [TMS Trusted Services \[Page 73\]](#), you can give the user TMSADM more authorizations in one or more systems. This is a good idea, for example, if you want to allow all members of the development team to import requests into the quality assurance system, without having to give each member a user in this system.

Procedure

If you want to extend the default authorizations for user TMSADM or give another user authorizations for TMS, proceed as follows:

1. Use the authorization object S_CTS_ADMI to create the appropriate authorizations.
2. Assign the authorizations to authorization profiles.
3. Give the user the required authorization profiles.

For more information on authorizations, see [Authorizations in the Transport Organizer \[Page 69\]](#).