

Pricing and Conditions (SD-BF-PR)



HELP.SDBFPR

Release 4.6C



Copyright

© Copyright 2000 SAP AG. All rights reserved.

No part of this brochure may be reproduced or transmitted in any form or for any purpose without the express permission of SAP AG. The information contained herein may be changed without prior notice.

Some software products marketed by SAP AG and its distributors contain proprietary software components of other software vendors.

Microsoft®, WINDOWS®, NT®, EXCEL®, Word® and SQL Server® are registered trademarks of Microsoft Corporation.

IBM®, DB2®, OS/2®, DB2/6000®, Parallel Sysplex®, MVS/ESA®, RS/6000®, AIX®, S/390®, AS/400®, OS/390®, and OS/400® are registered trademarks of IBM Corporation.

ORACLE® is a registered trademark of ORACLE Corporation, California, USA.

INFORMIX®-OnLine for SAP and Informix® Dynamic Server™ are registered trademarks of Informix Software Incorporated.

UNIX®, X/Open®, OSF/1®, and Motif® are registered trademarks of The Open Group.







HTML, DHTML, XML, XHTML are trademarks or registered trademarks of W3C®, World Wide Web Consortium, Laboratory for Computer Science NE43-358, Massachusetts Institute of Technology, 545 Technology Square, Cambridge, MA 02139.

JAVA® is a registered trademark of Sun Microsystems, Inc., 901 San Antonio Road, Palo Alto, CA 94303 USA.

JAVASCRIPT® is a registered trademark of Sun Microsystems, Inc., used under license for technology invented and implemented by Netscape.

SAP, SAP Logo, mySAP.com, mySAP.com Marketplace, mySAP.com Workplace, mySAP.com Business Scenarios, mySAP.com Application Hosting, WebFlow, R/2, R/3, RIVA, ABAP, SAP Business Workflow, SAP EarlyWatch, SAP ArchiveLink, BAPI, SAPPHIRE, Management Cockpit, SEM, are trademarks or registered trademarks of SAP AG in Germany and in several other countries all over the world. All other products mentioned are trademarks or registered trademarks of their respective companies.

Icons

Icon	Meaning
	Caution
	Example
	Note
	Recommendation
	Syntax
	Tip

Contents

Pricing and Conditions (SD-BF-PR)	7
Pricing and Conditions	8
Introduction to the Condition Technique	10
Condition Types	11
Condition Tables	13
Access Sequences	17
Pricing Procedures	19
How Condition Technique Elements Work Together	20
Pricing in Sales Documents	21
Pricing Elements in Sales Order Processing	22
Prices	24
Surcharges and discounts	26
Freight Charges	28
Sales Taxes	29
Prerequisites for Automatic Pricing	30
Pricing Screens in Sales Documents	31
Header and Item Conditions	33
Manual Pricing	34
Distribution Between Header and Items	36
Implementing a New Pricing Procedure	38
Pricing Analysis	39
Condition Records	40
Condition Maintenance	41
Maintaining Condition Records	43
Customer-Specific Enhancements	48
Maintaining with Selection Using the Condition Type	50
Dynamic Field Check	52
Release Procedures	53
Validity Periods	56
Table Displays	58
Long Texts in Conditions	59
Pricing Scales	60
Pricing with Graduated Scales	62
Condition Supplements	64
Condition Exclusion	66
Upper and Lower Limits	67
Reference Conditions	68
Changing Condition Records	69
Change Documents for Condition Records	71
Copying Condition Records	73
Copying Condition Records	75
Selecting From Alternative Copying Rules	76
Deleting a Condition Record	77
Condition Index	78
Special Condition Record Functions	80
Terms of Payment	81

Tracking Cumulative Values With Condition Update	82
Maximum Values	83
Maximum Quantities	84
Maximum Number of Sales Orders	85
Special Pricing Functions	86
Promotional Pricing Agreements	87
Creating Promotions and Sales Deals	89
Creating Condition Records Within a Sales Deal	90
Release Status	91
Budget Assignment	93
Budget Assignment in SD	94
Using Variable Views of Condition Record Data	96
Selecting Variable Views of Condition Records	97
Customer Expected Price	98
Entering Customer Expected Price in the Sales Order	100
Processing Lists of Orders With Price Discrepancies	101
Cost	102
Gross Prices	103
Condition Exclusion	105
Variant Conditions	108
Minimum Order Value	109
Sales Order Costing in Pricing	110
Duplicating Conditions	112
Cumulating Conditions	113
Group Conditions	114
Pallet Discounts	116
Hierarchical Accesses	120
Data Determination in the Access	122
Data Determination using a Communication Structure	124
Data Determination using Routines	126
Data Determination for Sales Deals	128
Price Book	130
Condition Interchange	132
Idocs and Condition Technology	133
Outbound Processing	135
Inbound Processing	138
Distribution Scenarios	140
Customizing	141
Customer Exits	142
Serialization	143
Pricing Information and Analysis	144
Pricing Analysis	145
Pricing Reports	146
Creating Pricing Reports	147
Running a Pricing Report	149
Net Price Lists	151

Pricing and Conditions (SD-BF-PR)

Pricing and Conditions

Pricing and Conditions

Purpose

The term *pricing* is used broadly to describe the calculation of prices (for external use by customers or vendors) and costs (for internal purposes, such as cost accounting). *Conditions* represent a set of circumstances that apply when a price is calculated. For example, a particular customer orders a certain quantity of a particular product on a certain day. The variable factors here - the customer, the product, the order quantity, the date - determine the final price the customer gets. The information about each of these factors can be stored in the system as master data. This master data is stored in the form of *condition records*.

The Condition Technique in Pricing

The *condition technique* refers to the method by which the system determines prices from information stored in condition records. In Sales and Distribution, the various elements used in the condition technique are set up and controlled in Customizing. During sales order processing, the system uses the condition technique to determine a variety of important pricing information. For example, the system automatically determines which gross price the customer should be charged and which discounts and surcharges are relevant given the conditions that apply.



Example of Pricing in the Sales Order

The following figure shows how the condition technique works in the background to produce the pricing information. The diagram shows how the various elements in the condition technique work together.

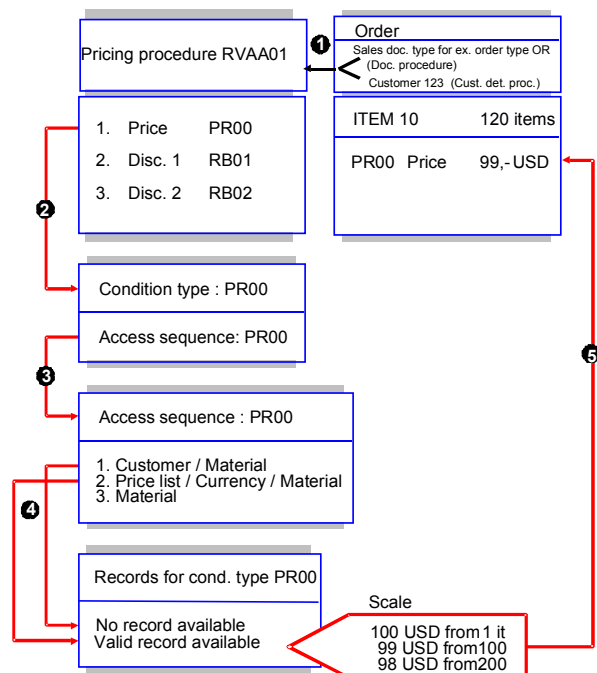

Pricing and Conditions

1. The system determines the pricing procedure according to information defined in the sales document type and the customer master record.
2. The pricing procedure defines the valid condition types and the sequence in which they appear in the sales order. In the example, the system takes the first condition type (PR00) in the pricing procedure and begins the search for a valid condition record.
3. Each condition type in the pricing procedure can have an access sequence assigned to it. In this case, the system uses access sequence PR00. The system checks the accesses until it finds a valid condition record. (Although you cannot see this in the diagram, each access specifies a particular condition table. The table provides the key with which the system searches for records).
4. In the example, the first access (searching for a customer-specific material price) is unsuccessful. The system moves on to the next access and finds a valid record.
5. The system determines the price according to information stored in the condition record. If a pricing scale exists, the system calculates the appropriate price. In the example, the sales order item is for 120 pieces of the material. Using the scale price that applies to quantities from 100 pieces and more, the system determines a price of USD 99 per piece.

The system repeats this process for each condition type in the pricing procedure determines a final price.

For further information on the condition technique, see [Introduction to the Condition Technique \[Page 10\]](#)

Introduction to the Condition Technique

Use

This section describes the elements within the condition technique. It is organized to reflect the likely sequence of events that you go through when you implement pricing in Customizing. The standard R/3 System includes predefined elements for routine pricing activities. For example, the standard system includes condition types for basic pricing elements, such as material prices, customer and material discounts, and surcharges such as freight and sales taxes. In the case of each element, you can use the standard version, modify the standard version, or create entirely new definitions to suit your own business needs. The sequence of activities is generally as follows:

1. Define condition types for each of the price elements (prices, discounts, and surcharges) that occur in your daily business transactions.
2. Define the condition tables that enable you to store and retrieve condition records for each of the different condition types.
3. Define the access sequences that enable the system to find valid condition records.
4. Group condition types and establish their sequence in pricing procedures.

For more information about implementing and customizing pricing in sales order processing, see Customizing for Sales and Distribution.

For a more technical description of how the condition technique works, see the Business Workflow documentation for Message Control.

Elements Used in the Condition Technique

[Condition Types \[Page 11\]](#)

[Condition Tables \[Page 13\]](#)

[Access Sequences \[Page 17\]](#)

[Pricing procedures \[Page 19\]](#)

Condition Types

Use

A condition type is a representation in the system of some aspect of your daily pricing activities. For example, you can define a different condition type for each kind of price, discount or surcharge that occurs in your business transactions.



Example of a Condition Type

You define the condition type for a special material discount. You specify that the system calculates the discount as an amount (for example, a discount of USD 1 per sales unit). Alternatively, you can specify that the system calculates the discount as a percentage (for example: a 2% discount for orders over 1,000 units). If you want to use both possibilities, you must define two separate condition types. The following figure illustrates how condition types can be used during pricing in a sales document.

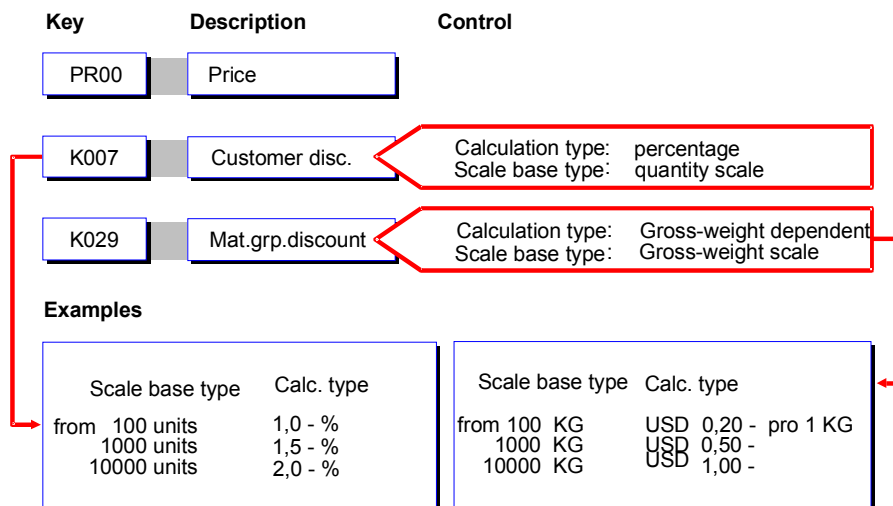

In the example in the preceding figure, two discounts apply to the item in the sales order. The first discount is a percentage discount based on the quantity ordered. The second discount is a fixed discount based on the total weight of the item.



You determine the calculation type for a condition type in Customizing. This determines how the system calculates prices, discounts and surcharges for a condition. When setting up condition records, you can enter a different calculation type than the one in Customizing. At present all available calculation types are permitted. The field 'Calculation type' can however not be accessed if this field is left empty. After the data release has been printed, if the field has not been completed manually, the proposal is automatically taken from Customizing. After this it is no longer possible to make manual changes.

Condition Types

If you use different calculation types for what are otherwise the same conditions (for example, percentage, as a fixed amount or quantity-dependent), you do not have to define different condition types in Customizing. You can set a different calculation type when maintaining the individual condition records.

Condition Types in the Standard R/3 System

The standard system includes, among many others, the following predefined condition types:

Condition type	Description
PR00	Price
K004	Material discount
K005	Customer-specific material discount
K007	Customer discount
K020	Price group discount
KF00	Freight surcharge (by item)
UTX1	State tax
UTX2	County tax
UTX3	City tax

Creating and Maintaining Condition Types

You can change and maintain condition types provided in the standard version of the SAP R/3 System or you can create new condition types to suit the needs of your own organization. You create and maintain condition types in Customizing.

To reach the condition type screen from the initial Customizing screen for Sales and Distribution:

1. *Basic Functions* → *Pricing* → *Pricing Control* → *Define condition types*.

A dialog-box appears, listing the transaction options. Select the corresponding transaction for defining the condition types.

2. In the *Conditions: Condition Types* view, you can change existing condition types or create new ones.

Condition Tables

Use

A *condition table* defines the combination of fields (the key) that identifies an individual condition record. A condition record is how the system stores the specific condition data that you enter in the system as condition records. For example, when you enter the price for a product or a special discount for a good customer, you create individual condition records.



Example of a Condition Table

A sales department creates condition records for customer-specific material prices. The standard R/3 System includes condition table 005 for this purpose. The key of table 005 includes the following fields:

- Sales organization
- Distribution channel
- Customer
- Material

The first two fields identify important organizational data and the last two fields express the relationship between customers and specific materials. When the sales department creates a condition record for a material price or discount that is specific to one customer, the system automatically uses condition table 005 to define the key and store the record.

The following figure illustrates the connection between the condition table and the subsequent condition records.

Condition Tables

Condition tables

004	Material
005	Customer/Material
006	Price list cat./Currency/Material
007	Division / Material
.	.
.	.

Selected fields from condition table 005:

- Sales organization
- Distribution channel
- Customer
- Material

Create condition

Sales organization	0001
Distribution channel	01
Customer	K1
Material :	
M1	10,-
M2	15,-

Condition Tables in the Standard Version

The standard system includes predefined condition tables and specifies them for each access in each predefined access sequence.

Creating or Maintaining Condition Tables

You can change and maintain the condition tables in the standard system. You can also create new condition tables to meet the needs of your own organization. You create and maintain condition tables in Customizing.

From the initial screen of Customizing for Sales and Distribution, you reach the condition table screens by choosing *Basic functions* → *Pricing* → *Pricing Control* → *Define condition tables*. Then select the mode you want to work with (create, change, display).

Information About Fields

The fields that you choose to make up the key are called the *selected fields*. The fields from which you can make your selection are called the *allowed fields*.

Selected Fields

The preceding figure shows the fields that make up the key for condition table 005 (the table for customer/material condition records in Sales). The selected fields show organizational data, such

as *Sales organization*. The fields *Customer* and *Material* define the relationship between a particular customer and material.

Field Catalog (Allowed Fields)

When you select fields for the key, you must choose the fields from the list of allowed fields.

Making Changes to Condition Tables

You can make limited changes to existing condition tables. For example, you can change the name of the table or the format of the fast entry screens for the condition records. (Fast entry screens are screens where you can quickly, on a single screen, create and maintain the condition records that refer to the condition table).

Format of a Fast-Entry Screen

The screen consists of header and item lines. Each item line represents a separate condition record. The header lines include the fields that are general to all item lines. When deciding on the format of the fast-entry screen, you can determine whether each field in the key appears as a line in the header or as an item line.

Changing the Format of a Fast-Entry Screen

To change the format of the Fast-Entry screen, choose F6 (*Technical View*) on the screen where you create or maintain a condition table.

When you determine the format, you have the following possibilities:

If you want the...	Do the following...
Field to appear as a header line	Leave the line field blank
Field to appear as an item	Mark the line field
Text for an item line to appear	Mark the text field

After you make changes to a condition table, choose F16 (*Generate*) to regenerate the table.

Creating a New Condition Table

You can create new condition tables to meet the pricing needs of your organization. When you create a new condition table, you select a combination of fields from the list of allowed fields. The selected fields define the key for the subsequent condition records.

Before you select the fields for the key, there are two things to consider:

- The sequence (or hierarchy) of the fields
- Which fields you want to appear in the header and item areas of the corresponding fast-entry screens

Important Fields

In sales, the fields you should take into consideration are *Sales organization* and *Distribution channel*. The sales organization is nearly always used as a criteria in pricing, because different sales organizations often want to use their own prices, discounts, and surcharges. If you use the

Condition Tables

sales organization as a criterion in pricing, you should also use the distribution channel. If you do not want to establish different prices, discounts, and surcharges for each distribution channel, use the field anyway. In Customizing for Sales, you can use one distribution channel as a reference for all others (thereby sharing the same pricing data).

Deciding the Sequence of Fields

The order of the fields in a condition table affects the performance of the system during pricing. Two general guidelines will help you create an efficient condition table:

1. If you select fields that are connected to the structure of your organization (for example, sales organization and distribution channel), assign the fields according to the level of general applicability: Put the most general field, for example, the *sales organization* in the highest position and the most specific field in the lowest.
2. After organizational fields, place fields from the document header before those that come from the item level. (For example, *Customer* comes before *Material*)

After you have selected the fields for the key on the screen where you maintain and define condition tables, choose F16 *Generate* to generate the table in the system. Generation prepares the condition table for storing condition data.

Access Sequences

Use

An *access sequence* is a search strategy that the system uses to find valid data for a particular condition type. It determines the sequence in which the system searches for data. The access sequence consists of one or more accesses. The sequence of the accesses establishes which condition records have priority over others. The accesses tell the system where to look first, second, and so on, until it finds a valid condition record. You specify an access sequence for each condition type for which you create condition records.



There are some condition types for which you do not create condition records (header discounts that you can only enter manually, for example). These condition types do not require an access sequence.



A sales department may offer customers different kinds of prices. The department may create, for example, the following condition records in the system:

- A basic price for a material
- A special customer-specific price for the same material
- A price list for major customers

During sales order processing, a customer may, in theory, qualify for all three prices. The access sequence enables the system to access the data records in a particular sequence until it finds a valid price. In this example, the sales department may want to use the most favourable price for a certain customer. For this reason, it ensures that the system searches for a customer-specific price. The following figure shows how the system searches for the relevant record.

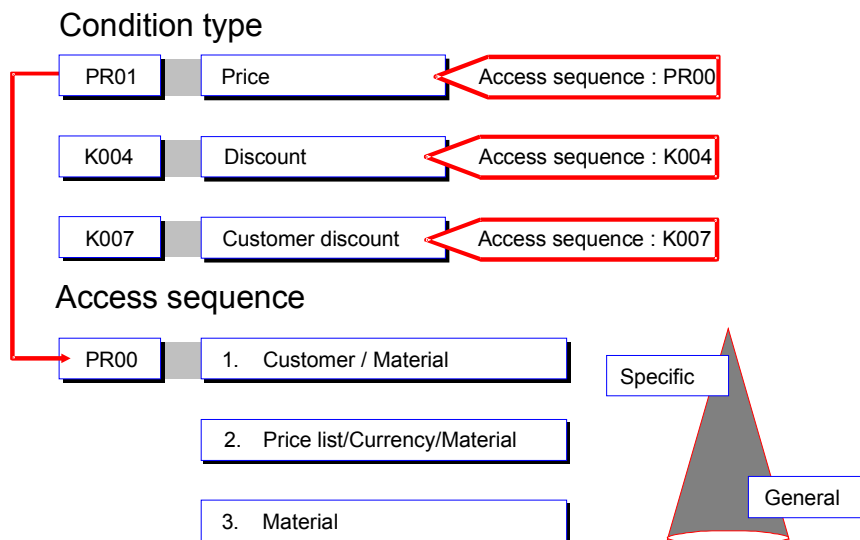

Access Sequences

Access Sequences in the Standard R/3 System

The standard R/3 System contains access sequences that are predefined for each of the standard condition types. The names of the access sequences often correspond to the condition types for which they were designed. For example, the access sequence for a material discount (condition type K004) is also called K004.

Creating and Maintaining Access Sequences

You create and maintain access sequences in Customizing. For more information, see the online *Implementation Guide* for Sales and Distribution.

To reach the access sequence screen, go to the initial screen for Sales and Distribution Customizing and choose:

1. Basic Functions → Pricing → Pricing Control → Define access sequences
Select the transaction that you want to execute (*Maintain access*).

Pricing Procedures

Use

The primary job of a pricing procedure is to define a group of condition types in a particular sequence. The pricing procedure also determines:

- Which sub-totals appear during pricing
- To what extent pricing can be processed manually
- Which method the system uses to calculate percentage discounts and surcharges
- Which requirements for a particular condition type must be fulfilled before the system takes the condition into account



Example of a Pricing Procedure

If a sales department processes sales orders for a variety of foreign customers, the department can group the customers by country or region. A pricing procedure can then be defined for each group of customers. Each procedure can include condition types that determine, for example, country-specific taxes. In sales order processing, you can specify pricing procedures for specific customers and for sales document types. The system automatically determines which procedure to use.

Pricing Procedures in the R/3 System

The standard system contains pre-defined pricing procedures, which contain frequently used condition types along with their corresponding access sequences. You can, of course, modify these procedures or create your own from scratch.

Creating and Maintaining Pricing Procedures

You create or maintain pricing procedures in Customizing for Sales. For more information on creating pricing procedures, see the online *Implementation Guide* for Sales and Distribution.

To reach the pricing procedure screen from SD Customizing:

1. Choose *Basic Functions* → *Pricing* → *Pricing control* → *Define and assign pricing procedures*.
2. Select the transaction that you want to execute.

How Condition Technique Elements Work Together

How Condition Technique Elements Work Together

The following figure illustrates the relationships between elements of the condition technique.

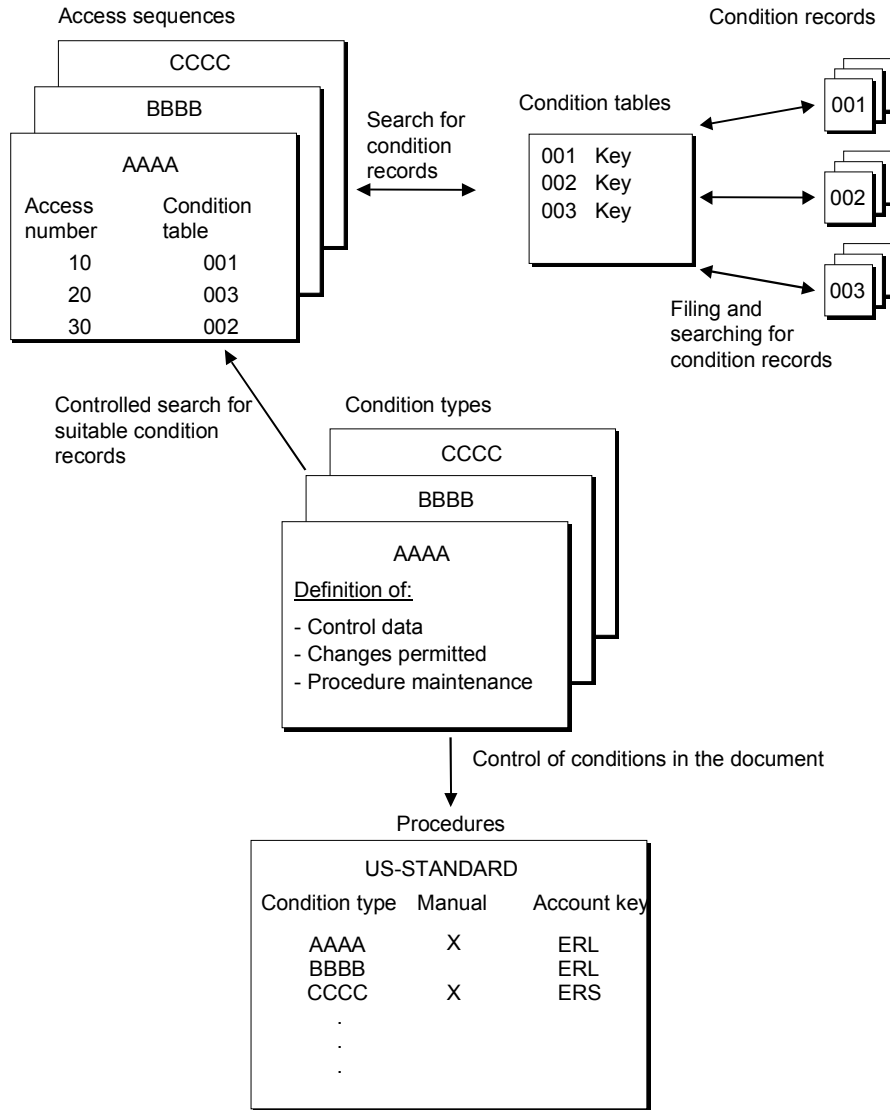

Pricing in Sales Documents

Use

This section is intended to provide an overview of the pricing elements used in order processing. In addition, the section shows you how to work with pricing during day-to-day sales order processing. During pricing, the system calculates amounts based on a combination of automatic procedures and manually entered data. The system automatically transfers pricing data - for example, information about prices, surcharges, and discounts - from the condition records into sales and billing documents. Depending on the pricing policies of your company, you may be able to change prices manually during sales order processing. You may, for example, be able to enter or change certain discounts within a specified range.

Pricing Elements in Sales Order Processing

Pricing Elements in Sales Order Processing

Use

All of the pricing elements that you use in your day-to-day pricing procedures - the prices, surcharges, discounts, freight charges, and taxes - are defined in the R/3 system as condition types. This section gives you an overview of the pricing elements and their corresponding condition types that appear in Sales & Distribution (SD). When you create or maintain pricing information for a particular pricing element in the system, you create condition records. For more information about the tasks of creating and maintaining conditions, see [Working with Condition Records \[Page 40\]](#).

Further Information

The task of actually defining condition types is part of system configuration and maintenance. For further information on condition types, see [Introduction to the Condition Technique \[Page 10\]](#).

Pricing Elements in the Standard Version

Pricing elements are divided into four categories:

[Prices \[Page 24\]](#)

[Surcharges and Discounts \[Page 26\]](#)

[Freight Costs \[Page 28\]](#)

[Sales Taxes \[Page 29\]](#)

When entering sales orders, the system can carry out an automatic check. During sales order entry, the system can calculate prices automatically by finding a gross price, deducting all the relevant discounts and adding any surcharges such as freight and sales tax. The following figure illustrates how the system represents various pricing elements of everyday business.

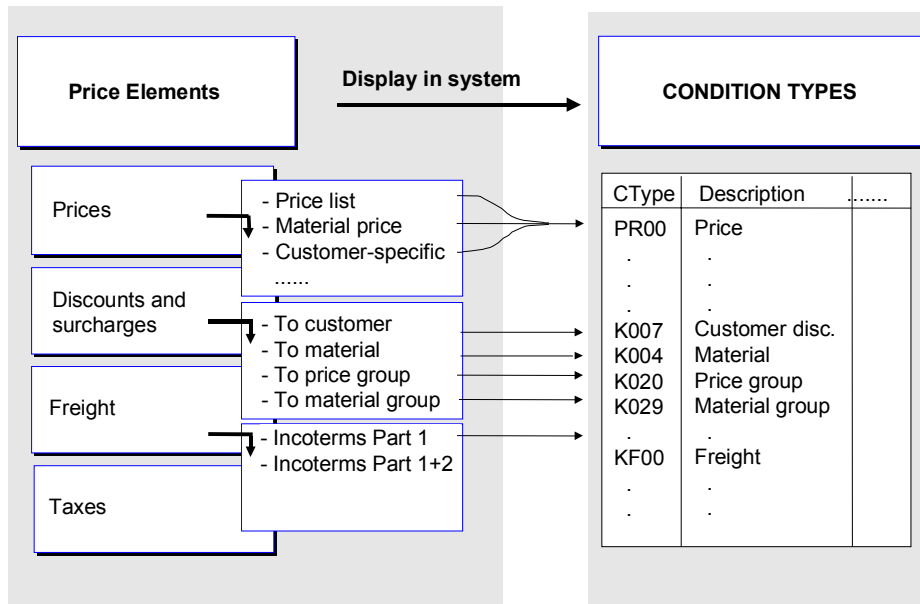

Pricing Elements in Sales Order Processing

In the figure, you can see that the price of a material is represented by one condition type (PR00). However, the price of a material can be based on different kinds of pricing records. The price can come from a price list; it can be specific to a particular customer, or it may be a simple material price. On the other hand, each discount, surcharge, freight charge, and tax is defined by its own condition type.

Prices

Prices

Use

In the standard R/3 System, the basis of pricing during sales order processing is the gross price of a material. The following kinds of price are predefined:

- Material price
- Price list type
- Customer-specific price

Selecting from Competing Pricing Records

During automatic pricing, the system looks for a gross price. Since you can store different kinds of pricing information in the system, pricing records can compete with each other in certain circumstances. For example, in addition to a basic material price, you may have a special material price for a particular customer.

In the standard R/3 System, the system selects the most specific record - the customer-specific price. If no customer-specific price exists, the system looks for a valid price list type. If no valid price list type exists, the system takes the basic material price. This search strategy is determined during system configuration in Customizing for Sales and Distribution. For further information, see [Access Sequences \[Page 17\]](#).

Material Prices

When you create a material price, you specify:

- A price or a pricing scale for a specific material
- A combination of sales organization and distribution channel for which the material price is valid.



In Customizing for Sales and Distribution, you can specify that pricing information assigned to a particular combination of sales organization and distribution channel can be shared by other combinations. For more information, see the online *Implementation Guide*.

Price List Types

Depending on your company's pricing policies, you can define your own price list types to suit the needs of your business. For example, you can define price list types by customer groups (wholesale, retail, and so on) and by currency (price lists for each foreign country you deal with). Condition records are created for each price list type. You do this using the same organizational data as for material prices (sales organization, distribution channel). You can then assign price list types to each customer in their master record.

Customer-Specific Prices

If you give special prices to different customers, you can create customer-specific pricing records. In addition to the same organizational data you enter for material prices (sales

organization, distribution channel), you assign the pricing record to a specific combination of customer and material.

Surcharges and discounts

Surcharges and discounts

Use

The standard R/3 System includes a variety of commonly used discounts. If your business requires it, you can define special discounts and surcharges in Customizing for Sales.

Discounts in R/3

The standard system includes, among many others, the following discounts:

Discount (Key)	Kind of discount
Customer (K007)	Percentage
Material (K004)	Absolute
Price group (K020)	Percentage
Material group (K029)	Absolute discount by weight
Customer/material (K005)	Absolute
Customer/material group (K030)	Percentage
Price group/material (K032)	Absolute
Price group/material group (K030)	Percentage
Rebate processing (BO01)	Group rebate (%)
Rebate processing (BO02)	Material rebate (fixed)
Rebate processing (BO03)	Customer rebate (%)
Inter-company processing (PI01)	Intercompany discount (fixed)
Inter-company billing (PI02)	Intercompany discount (%)
Invoice lists (RL00)	Factoring discount
Invoice lists (MW15)	Factoring discount tax

You can use any of these standard discounts to create condition records. During automatic pricing, the system considers the discounts that apply in the circumstances and searches for valid condition records. In the case of discounts that refer to a group of some kind (for example, material and price groups), you must assign the group in the corresponding customer or material master record before automatic pricing takes place.

Further Information

For further information on these discounts, contact your system administrator. The system administrator will be able to tell you how the individual discounts are set up in the system. You can also, during sales order processing, branch from each pricing element in the document to screens that give you more information. You can see, for example, some of the data - the relevant condition record and pricing scale information, etc. - that the system uses to calculate a pricing element.

Freight Charges

Freight Charges

Use

You can pass freight costs on to your customers by using special condition types that relate to shipping and freight charges. The standard SD application component includes predefined condition types that are based on Incoterms.

Incoterms

Incoterms are the internationally recognized shipping terms that establish the respective liabilities of both the shipping party and the recipient. For example, a common shipping term is FOB (Free on board). The term can be further qualified by adding the loading port, for example, FOB Boston.

You can create condition records either:

- Based solely on the first part of the Incoterm (for example, FOB)
- Based on the combination of parts 1 and 2 (for example, FOB and Boston)

Freight Conditions

The standard R/3 System includes two predefined freight conditions:

- Freight condition type KF00 applies to each item in a sales document. During automatic pricing, the system searches for valid condition records that apply to this freight condition.
- Freight condition type HD00 can only be applied to an entire document. You enter this freight manually during sales order processing.

For further information on entering freight conditions, see [Manual Pricing \[Page 34\]](#).

Sales Taxes

Use

The standard R/3 System includes condition types that define country-specific sales taxes. For example, there are condition types for Value-Added Tax (VAT) for use in some European countries. For tax determination in the U.S., the standard system includes condition types for state, county, and city sales taxes, as well as taxes based on tax jurisdiction codes.

Automatic Calculation of Sales Taxes

During the automatic calculation of sales taxes, the system takes the following factors into account:

- Whether the business being transacted is domestic or foreign
- The tax classification of the customer's ship-to party.(Customers who are non-profit organizations, for example, may be exempt from paying sales tax.)
- The tax classification of the material.(Some products may not be taxed at all while others may have a reduced tax rate.)

With the help of these criteria, the tax rate per item is determined in the sales order. In Customizing, you set up a separate condition type for the tax rate (taxes on sales and purchases).

Material Tax Classification

You specify the tax classification for a material in the material master record. During sales order processing, the system automatically transfers the tax classification into the sales document.

Customer Tax Classification

You specify the tax classification for a customer in the customer master record. During sales order processing, the system automatically transfers the tax classification into the sales document.

Prerequisites for Automatic Pricing

Prerequisites for Automatic Pricing

For the system to automatically determine pricing, the following prerequisites must be met:

- Condition records must already exist in the system for each of the condition types that you want the system to apply automatically. For further information about creating and maintaining condition records, see [Condition Records \[Page 40\]](#).
- Where necessary, data must be maintained in the corresponding customer and material master records. If, for example, you want to apply discounts to special groups of customers or materials, then the system can only carry out automatic pricing when the groups are specified within the relevant customer or material master records.

Material Master Data

The price-related fields in the material master record can be found in the *Sales: SalesOrg 1 and SalesOrg2* screens.

- **Tax classification:** Indicates to what extent the material is liable for sales taxes.
- **Price material:** In this field you can specify another material as a reference for pricing information. If you specify a reference, the system, uses all the condition records that apply to the reference material during automatic pricing.
- **Material group:** Defines a group of materials for which you want to apply the same condition record. For example, using a material group, you can specify a discount that applies to a particular range of products.
- **Cash discount:** In this field you can specify whether or not the material qualifies for a cash discount.

Customer Master Data

Most fields in the customer master record that relate to pricing appear on the *Orders* tab page under sales data.

- **Customer pricing procedure:** Here you specify the pricing procedure for a customer. You create and maintain pricing procedures in Customizing for Sales and Distribution. During sales order processing the pricing procedure determines the kinds of pricing element you can use and in which sequence they are processed.
- **Price list:** Price list types allow you to apply a material price in a particular currency to a group of customers. For example, you can specify a price list type that applies to all wholesale customers in one of your export markets.
- **Price group:** Price groups let you apply a discount to a particular group of customers.
- **Tax classification:** (You can find tax classification on the *Billing* tab page.) You can maintain tax classifications for your customers here.

Pricing Screens in Sales Documents

Use

The system displays pricing information for all sales documents on *pricing screens*. There is a pricing screen that shows pricing information for the document header and a pricing screen that shows information for each item in the document. You specify the condition types that appear in the pricing screens and the sequence in which they appear is controlled in Customizing for Sales and Distribution.

Header Pricing Screen

No automatic pricing takes place at the header level of a document so the header pricing screen mostly displays a summary of the pricing calculations for all items in the document. However, the header pricing screen also includes information about special condition types that you can apply manually at the header level and that apply to all items in the document. For example, you can manually enter a discount that the system automatically distributes among the various items according to factors such as order quantity or weight. For further information on header conditions, see [Freight Costs \[Page 28\]](#).

Item Pricing Screen

The item pricing screen displays details of each price element that applies to an item. For example, for each item in a sales order, you can see the amounts, currency, and units or measure on which the system based its calculations.

Which Pricing Elements Appear in the Pricing Screens

You determine the kind and sequence of pricing elements that appear in the pricing screens in Customizing for Sales and Distribution. Your system administrator determines which condition types you can work with and in which sequence they appear.

Example

The sequence consists of various pricing elements (price, discounts, and surcharges) and subtotals. For example, all the discounts that apply in this case are subtotalled before the surcharge for freight costs is added. The system then calculates the appropriate sales tax and finally produces a net value for the order.

Statistical Pricing Elements

Statistical pricing elements - such as cash discount, cost, and profit margin - are for information only and have no effect on the net order value. They appear at the bottom of the pricing screen.

How to Select Pricing Screens

When you are working in a document, you can branch to the header and item pricing screens:

- To reach the header pricing screen, choose *Goto* → *Header* → *Conditions*.
- To reach the item pricing screen, mark the appropriate item and choose *Goto* → *Item* → *Conditions*.

Header and Item Conditions

Use

The standard system includes condition types that you can only apply at the header level, the *header conditions*. Condition types that you can only use for items are called *item conditions*. The standard system also includes some condition types that can be used both at header and item level: Percent from gross (RA01) Absolute discount (RB00) Weight discount (RD00).

Header Conditions

Automatic pricing does not take header conditions into account; you can not create condition records for them in the standard system. Header conditions are entered manually in order processing. R/3 includes the following header conditions:

- Percent discount (HA00)
- Absolute discount (HB00)
- Freight (HD00)
- Order value (HM00)

Item Conditions

In the standard system, most condition types are defined as item conditions. Examples of item conditions are:

- Material discount (K004)
- Customer/Material (K005)
- Customer discount (K007)
- Material price (PR01)

Displaying Header and Item Conditions

From the header and item pricing screens, you can branch to detailed information about each condition type that appears. From the header pricing screen, place the cursor on the condition for which you require detailed information.

- In the header price screen, choose *Condition detail*. The system displays data it uses to calculate the amount of the condition (for example, the kind of pricing scale, quantity conversion, the scale base value, the document currency, and so on). From the details screen, you can choose *Goto* → *Condition record* to see the specific condition record that the system accesses. From the item pricing screen, select the condition for which you require detailed information.
- Accordingly choose *Condition detail* in the item price screen. To see the specific condition record that the system accesses, choose *Goto* → *Condition record*.

Manual Pricing

Manual Pricing

Use

During sales order processing, you can manipulate pricing at both the header and item level. The options for manual processing of a price screen depend on the individual condition types. In Customizing the level of manipulability for each condition type is precisely defined. The following definitions are possible:

- A condition type is not restricted with regard to its manual processing (for example, the entry of freight costs).
- Manual entries have priority over results of pricing determined automatically or vice versa.
- A condition type cannot be changed manually (for example, in the case of automatically determined sales taxes).

Making Changes During Manual Processing

Depending on the extent to which manual processing is allowed for a condition type, you can perform the following activities during sales order processing:

- You can change a condition amount.
- You can delete a pricing element.
- You can enter additional pricing elements.

If you want to add pricing elements to a sales document, you can only enter pricing elements for which corresponding condition types are defined and for which manual processing is allowed.

Adding Pricing Elements Manually

You can enter pricing elements manually at both the header and item level.

Adding an Item Condition Manually

To enter a customer discount manually in the pricing screen of a sales order item:

1. In the pricing screen of the sales order, choose *Add line*.
You reach the data screen where you can enter an additional condition.
2. Enter the customer discount **K007** in the *Condition type* field.
3. Enter a percentage rate in the *Rate* field.
4. Select *ENTER*.

The system automatically inserts the new condition according to the sequence specified in the corresponding pricing procedure.



You can choose *Update prices* on the pricing screen for a document item. To do this, you must select a pricing type. The prices will be updated according to the pricing type you selected.

Adding a Header Condition Manually

When including header conditions in the header pricing screen, proceed in the same way as described for item conditions. Afterwards you must activate pricing, by choosing *Activate*. When you activate the header condition, the system distributes the condition value proportionally among the various items in the sales document. This distribution can be based on the order value of each individual item or on other criteria specified in Customizing for Sales. For further information on header conditions, see [Requirements for Automatic Pricing \[Page 30\]](#).

Changing Pricing Elements in Pricing Screens

Depending on how the condition types in your system have been configured, you can change automatically determined prices in the item pricing screen. If changes are allowed, you may be able, for example, to change the following data:

- The rate (for example, the amount of a price or the percentage of a discount).
- The currency in which the amount is calculated.
- The units of measure used to calculate the amount.

Some condition types (for example, sales taxes, and cash discount) cannot usually be changed manually.



Header conditions cannot be entered or changed at the item level, and item conditions cannot be entered or changed at the header level. Conditions that are defined as both header and item conditions can be edited at both levels.

Deleting Pricing Elements in the Header and Item Pricing Screens

You can delete most conditions in the pricing screens. Whether a condition type may be deleted is determined by the condition type set in Customizing for Sales.

To delete a condition, position the cursor on the corresponding condition and choose *Delete line*.

The system automatically recalculates pricing for the entire document.

Distribution Between Header and Items

Distribution Between Header and Items

Use

Header conditions apply to all items in the document and are automatically distributed to the items. A header condition can be based on either a percentage or on an absolute amount. If you enter a header condition that is based on a percentage (for example, a discount of 2%) the system automatically applies this percentage to all items in the document. If the header condition is an absolute amount, there are two different ways in which the system can distribute the amount among the items in the document:

The condition value of a header condition is either

- distributed proportionally among the items or
- the amount entered at header level is duplicated for each item.

You control the distribution of absolute header conditions in the group price field per condition type. In the standard version, condition type HB00 is marked as a header condition and as group condition. Condition type RB00 is only marked as a header condition:

Condition type	Description
HB00	Header discount distributed as percentage because it is marked as a header condition and as a group condition
RB00	Assigns the header discount to every item, because it is only marked as a header condition

Example

The following figure illustrates examples of the two variations. If you enter an absolute discount with condition type **RB00**, the system takes the amount you enter as a header condition and copies the identical amount for each item in the document. In the example, the absolute discount of USD 90 appears in each item. The total condition value for the document is USD 270. However, if you enter an absolute discount with condition type **HB00**, the system distributes the amount proportionally among the various items, in this case, according to value of the items. In the example, the absolute discount of USD 90 is distributed proportionally among the items. The total condition value for the document is USD 90.



The distribution of an absolute header condition need not be based on value. For example you can specify in Customizing for Sales that the distribution is based on the weight or volume of the different items. You specify the basis of the distribution in the *Alternative condition base value* field in the pricing screen.

Distribution Between Header and Items

Calculation of header conditions at item level

1. A value is assigned for each item

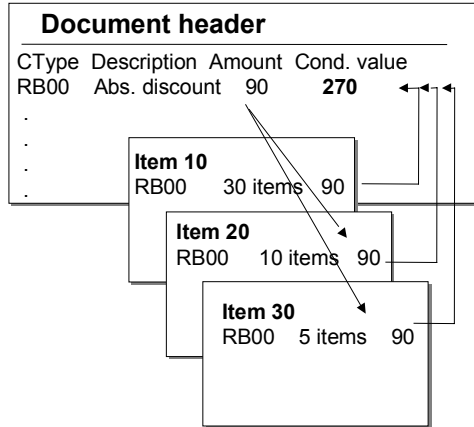

2. A value is assigned proportionately to the items

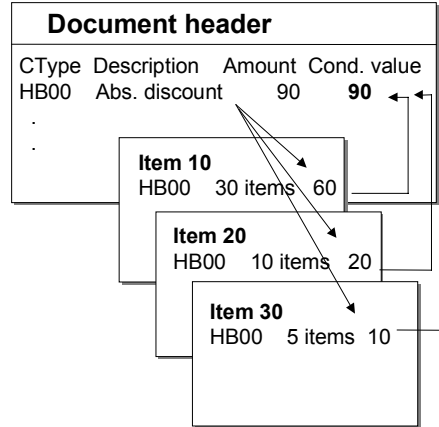

Rounding differences can occur during the distribution of absolute amounts. The system automatically evens these out by proposing the remainder to the largest item so that the value in the header is identical to the total of the values in the items.

Example:

A position has a net value of 200 USD, the second item has a value of 100 USD. A header surcharge of 10 USD should be allocated. The system sets a surcharge of 6.67 USD in the first item and 3.33 USD in the second item.

Implementing a New Pricing Procedure.

Implementing a New Pricing Procedure.

Use

You can implement a new pricing procedure in a sales or billing document. on the condition screens at item and header level.

In many cases, you may only want to redetermine tax or freight or you may want to receive manual conditions in spite of the revaluation. You can therefore agree a pricing type for a new pricing procedure in the dialog box.

The 'Update prices' function can also be implemented in the menu without a dialog box via *Edit - > New pricing document* (Transaction VA01 and VA02). In this case the pricing type which has been assigned to the pricing procedure in Customizing is valid. If no value is given, the pricing type "B" applies.

Selecting a pricing type is also possible for collective changes using transaction VA05.

Pricing Analysis

Use

When you are working in a sales or billing document, you can branch from the item pricing screen to a pricing analysis. You receive a list of all conditions for an item and a short overview of the transaction in automatic pricing. This information allows you to check how the system calculated the various pricing elements for an item.

Information in the Pricing Analysis

The analysis screen is divided into three.

In the **left-hand side** of the screen, an overview tree shows the four levels of pricing. These are:

- the pricing procedure
- condition types
- accesses
- any condition records found

In the **upper right-hand side** of the screen you receive more detailed information for the level of the overview tree that you have selected.

- At condition type level you receive information on the number of accesses and why accesses have not been implemented. If a requirement for a condition type in the pricing procedure has not been met, you have the option to display routines by selecting *Information*.
- At the access level you receive information on which fields work with an access. By selecting the *technical view* you can see the field names for an access.
- At condition record level you can branch into the relevant condition record.

In the **lower right-hand side of the screen** you receive additional documentation for the access and condition levels. You can use this if the information in the detail screen is not enough.

Condition Records

Condition Records

Use

This section explains how to perform day-to-day pricing activities during sales order processing. The section explains how to create and maintain pricing information by using condition records.

Purpose of Condition Records

Condition records allow you to store and retrieve pricing data in the system. All the pricing elements of your daily business - the prices, discounts, and surcharges for freight and taxes - that you want to use for automatic pricing must be stored in the system as condition records. You can define as many condition records as you want for the different pricing elements for any validity period.

You create condition records for all the pricing elements that the system takes into account during automatic pricing. During document processing, the system transfers data from the condition records and determines the amounts for individual pricing elements (prices, discounts and surcharges) and the final amount for the sales document.

Organizational Level

Pricing elements are generally managed at the sales organization and the distribution channel level. Therefore you always have to specify the organizational level when creating condition records. In the case of condition records for price groups, freight charges, and customer-specific prices and discounts, you must also enter the division. As a result, you can create conditions according to product groups with these price elements.

Creating Condition Records With Reference

If you want to create condition records based on records that already exist in the system, you can create condition records with reference. Creating condition records with reference reduces the data entry effort considerably. This method of creating condition records is especially useful for creating records that have similar data to the reference but have different validity periods.

You can overwrite any of the specifications of a condition record, thus using it as a reference. When you save an altered condition record, the system creates a new condition record.

- ➡ Material prices can be maintained directly in the material master record. or you go to the material master record and select *Extras* → *SD extras* → *Sales price* on the *Sales and Distribution* screens 1 or 2, or on the *Sales text* screen. (You must select the appropriate views beforehand).

Maintaining Pricing Related Master Data

During sales order processing the system can process some condition records only if corresponding data is maintained in the material or customer master records. If, for example, you want to apply discounts to certain customers by creating condition records for different price list types, you must maintain data in each of the relevant customer master records.

Condition Maintenance

Use

Condition maintenance in Release 4.6A has a new maintenance interface. The new interface enables mass maintenance of conditions relating to a particular feature (for example, relating to the customer). Condition records can be maintained using condition types and condition tables. You can, for example, maintain all material prices for a customer as well as the corresponding discounts or surcharges in one step.

To start condition maintenance, you can use the condition list function, which used to allow selection using condition types and condition tables but now also allows mass maintenance. You have the option of using pricing reports in the area menu COND_AV (Maintaining conditions) in the standard system. You can copy this standard menu and enhance it to suit your personal requirements.

The structure of the area menus and their assignment to employees is also used in condition maintenance. An example of this:



You have employees in your company that are responsible for condition agreements for specific customers.

You can take an existing or newly created condition list (in the standard system the condition list *Conditions by customer* uses the customer as a selection criteria) and specify the corresponding customers in the selection screen. Choose *Goto* → *Variants* → *Save as a selection variant* to receive a selection variant for the condition list.

In the area menu you can now integrate the condition list with the selection variants you wish to use, and the processor responsible can assign himself the job of maintaining these in the area menu. He is then free to assign his own work area.

The processor can maintain all prices, discounts and surcharges for his customers on his screen.

You can select condition records with condition lists for

- Creating
- Creating with reference
- Changing
- Displaying

condition records



You can also always maintain condition records for a specific condition type.

This is required, for example, when you define new condition types and they are not taken into account in selection using pricing reports.

Creating conditions for a condition type is described in the unit [Maintaining with Selection via Condition Type \[Page 50\]](#) and includes examples.

Condition Maintenance

Maintaining Condition Records

1. Access to navigation tree

You can get to the access for the new maintenance screen (from Release 4.6A) via the navigation menu.

Choose **Sales and Distribution** → **Master data** → **Conditions**

The following new transactions are offered:

Create conditions (transaction VK31)

Create conditions with reference (transaction VK34)

Change conditions (VK32)

Display conditions (VK33)



Maintenance with entry via the condition type can be reached via: **Sales and distribution** → **Master data** → **Selection using the condition type**

2. Selecting required pricing report

If you now select one of the transactions, for example, creating conditions with reference, you will reach the navigation tree, where you can choose from 18 pricing reports for selecting and maintaining condition records. At the **focus point** is one of the first **pricing reports** described for **maintaining conditions**.

Pricing reports for maintaining conditions (applies to condition types and condition tables)

Maintaining conditions uses the following new pricing reports. Their pre-defined selection does not specify a condition type:

- Selection of customer using pricing report 28 (internal name: /1SDBF12L/RV14AK28) with following condition tables:
 - Condition table 030 (customer/material group)
 - Condition table 305 (Customer/material with release status)
 - Condition table 307 (Customer with release status)
- Selection of material using pricing report 15 (internal name: /1SDBF12L/RV14AK15) with following condition tables:
 - Condition table 004 (material)
 - Condition table 304 (Material with release status)
- Selection of customer hierarchy using pricing report 30 (internal name: /1SDBF12L/RV14AK30) with following condition tables:
 - Condition table 064 (customer hierarchy)
 - Condition table 065 (customer hierarchy/material)

Maintaining Condition Records



By using the right mouse button, you can get information on the structure of a pricing report and the condition tables used.

Using the right mousebutton or by double clicking, you can select a pricing report.

The previous options from condition maintenance have been integrated into the new maintenance. But you can also take away the proposed condition type here, to enable both condition type and condition table maintenance. The following condition tables are available:

Pricing reports for maintaining prices:

- Selection of material price using pricing report 15 (internal name: /1SDBF12L/RV14AK15) with following condition tables:
 - Condition table 004 (material)
 - Condition table 304 (Material with release status)
- Selection of price list using pricing report 31 (internal name: /1SDBF12L/RV14AK31) with following condition tables:
 - Condition table 006 (price list type/currency/material)
 - Condition table 306 (price list type/currency/material with release status)
- Selection of customer-specific prices using pricing report 16 (internal name: /1SDBF12L/RV14AK16) with following condition tables:
 - Condition table 005 (customer/material)
 - Condition table 305 (Customer/material with release status)

Pricing reports for maintaining discounts and surcharges:

- Selection of customer using pricing report 17 (internal name: /1SDBF12L/RV14AK17) with following condition tables:
 - Condition table 007 (Division/customer)
 - Condition table 307 (Customer with release status)
- Selection of material using pricing report 04 (internal name: /1SDBF12L/RV14AK04) with following condition tables:
 - Condition table 004 (material)
 - Condition table 304 (Material with release status)
- Selection of price list using pricing report 19 (internal name: /1SDBF12L/RV14AK19) with following condition tables:
 - Condition table 020 (Division/price group)
- Selection of material group using pricing report 020 (internal name: /1SDBF12L/RV14AK20) with following condition tables:
 - Condition table 029 (material group)
- Selection of customer/material using pricing report 21 (internal name: /1SDBF12L/RV14AK21) with following condition tables:
 - Condition table 005 (customer/material)

Maintaining Condition Records

Condition table 305 (Customer/material with release status)

- Selection of customer/material group using pricing report 22 (internal name: /1SDBF12L/RV14AK22) with following condition tables:

Condition table 030 (customer/material group)

- Selection of price group/material using pricing report 23 (internal name: /1SDBF12L/RV14AK23) with following condition tables:

Condition table 032 (price group/material)

- Selection of price group/material group using pricing report 24 (internal name: /1SDBF12L/RV14AK24) with following condition tables:

Condition table 031 (price group/material group)

Pricing reports for maintaining freights:

- Selection of Incoterms using pricing report 03 (internal name: /1SDBF12L/RV14AK03) with following condition tables:

Condition table 033 (Incoterms)

Condition table 034 (Incoterms Part 1 + 2)

Pricing reports for maintaining taxes:

- Selection of VAT/ATX1 using pricing report 25 (internal name: /1SDBF12L/RV14AK25) with following condition tables:

Condition table 024 (Domestic taxes)

Condition table 011 (Export taxes)

- Selection of Canada/USA using pricing report 26 (internal name: /1SDBF12L/RV14AK26) with following condition tables:

Condition table 040 (Country/state/customer classification 1/Material classification 1)

Condition table 078 (Country of departure/destination country)

- Selection of I.E.P.S Mexico selection using pricing report 27 (internal name: /1SDBF12L/RV14AK27) with following condition tables:

Condition table 002 (Domestic taxes)

3. Complete selection screen

You reach a selection screen, in which you can enter concrete selection criteria, for example, the number of customers or materials.



You have the option of executing the selection screen without displaying it, possibly even with a pre-assigned selection variant (see Unit Customer-specific Enhancements)

4. Condition maintenance in condition overview screen



You must differentiate in the maintenance between the **overview screen** and the **fast entry screen**. You reach the overview screen described below first. It can be used to maintain conditions for **Changing conditions** and **Creating with reference** (also for displaying, which will no longer be taken into consideration in the condition maintenance description) You must decide

Maintaining Condition Records

on one of the pre-assigned condition tables in the overview screen for **Creating conditions**. Click on the icon for creating next to the short description for the condition table fields (highlighted). You then reach the fast entry screen, which will also be described.



Note that when creating with reference, new records are always created.

Therefore the entrant and the date of entry is continuously reset. If you have selected more condition records than those you wanted to create, you can delete these condition records from the selection. However if you are in 'Change' and you delete from the list, this means that the record is completely deleted.

After carrying out the selection you can use the transaction VK32 (Change Condition) to reach the conditions overview screen. This contains a list of the condition records to be maintained. In the list header a maximum of three fields are displayed, which are the same for all records, for example, sales organization. The list shows a group of condition records for every condition table. The heading for each group of conditions is the same as the heading for the field descriptions of the condition tables and is highlighted.

All of the price maintenance options are available. New developments in condition maintenance:

- Condition types and condition table maintenance in a screen This means you can change the validity period for different condition types or tables together
- Context sensitive right mouse button, equivalent to selecting icons
- Selection of fields for table maintenance with choice of one of the following screen variants:

All fields

Value limits for pricing

Validity period

Condition rate

Planned data

Tax data

Control data

Management data

Term of payment



You can define your own screen variants. The next unit *Customer-specific Enhancements* describes how to maintain new screen variants.

- Price simulation (see below for description)
- Tab pages with the following detail screens:

Validity Periods

Scales

Condition texts

Key

Pricing simulation

You can use the pricing simulation to estimate the results of a price change. You can choose several conditions and change them. Then before you save the changes, you can simulate pricing, which then displays the effects of the changes. A billing document is simulated for a customer and a material. As a result you receive a comparison of the old and new net value. You can also compare the old profit margin (net price minus cost price) with the new profit margin.

5. Initial creation of conditions in the fast entry screen

If you want to create conditions, choose the creation icons in the overview screen, relating to a condition table. You now reach the fast entry screen.

The fast entry screen enables the initial creation of conditions. This can still only be carried out for one condition table. If however, condition types have the same condition table, you can maintain condition records for different condition types.

Customer-Specific Enhancements

Customer-Specific Enhancements

Creating Pricing Reports with Variants

As a prerequisite for the following area menu enhancements, you may have to set up new pricing reports and/or selection variants for pricing reports.

Creating pricing reports is described in the unit [Creating Pricing Reports \[Page 147\]](#)

 You receive a selection variant for a pricing report, if you execute a pricing report (transaction V/LD), enter the selection criteria (for example, the number of customers) and then choose *Goto* → *Variants* → *Save as a variant*.

Maintaining Area Menus

The standard area menu for condition maintenance is COND_AV. This should not be changed, but – if required – can be copied and supplemented.

You can create your own area menus in Tools → ABAP Workbench → Development → Other tools → Area menu (Transaction SE43). You can create a tree structure in the area menu (more information on maintaining area menus can be found in the extended help in transaction se43). In the tree structure you can enter a pricing report with or without a variant for selection for condition maintenance. You can also determine whether the list should be executed with or without the selection screen when double-clicking in the navigation tree of the area menu (The selection screen is needed for the pricing reports pre-defined in the standard system, as they always have required entry fields). The pricing report is then available for selecting condition records to be maintained in your own area menu.



You want to give an employee a selection for maintaining conditions, containing the customers that he is responsible for.

- You execute pricing report 28 from the standard system. This contains customers as a selection.
- You enter the corresponding customer in the selection and save this selection as a variant.
- In the area menu that you assign to the employee, use the transaction SE43 to enter the name of the pricing report and the name of the selection variant.



Note that here the name of the pricing report is **not** entered as 28, as was the case when selecting the pricing report, but an internally assigned name, that was entered alongside 28. You can also see this name by displaying the pricing report (transaction V/LC). In our example the name is /1SDBF12L/RV14AK28.

Assigning Employees to the Area Menu

The area menus that you have set up can be assigned by an employee himself. He must go into the area menu and choose *Environment* → *Assign area menu*.

 In the area menu that you have assigned, only those activities that work with the selected pricing reports are supported. You cannot integrate any other activities here that, for example, use a transaction.

Defining Screen Variants

There are screen variants available in the standard system. In Customizing you can set up your own screen variants under General Settings → Field Display Characteristics → Configure application transaction fields (transaction SHD0):

- Choose *Goto* → *Screen variants*.
- Enter transaction VK31.
- Enter the program name SAPMV13A.
- Enter the screen number 3011.
- Choose *Create screen variant*.

The transaction chosen is then carried out. Also maintain the sequence and width of the fields.

There is an additional dialog box where you can select the field you want.



Not all of the options that you are offered are suitable for condition maintenance. You cannot select *obligatory*. The following functions are supported:

- Column sequence
- Column width
- Invisibility
- Issue only

You can select the screen variants for field selection in the conditions overview screen, for representing the condition records in table form.

Maintaining with Selection Using the Condition Type

Maintaining with Selection Using the Condition Type

Use

You can maintain specific condition records for a condition type.

Creating Condition Records

Using a condition record for a material price as an example, the following procedure describes how to create a condition record with reference to condition type PR00. You use the same procedure for condition records as for other pricing elements.

Steps:

1. Choose *Logistics* → *Sales and Distribution* → *Master Data*.
2. Choose *Conditions* → *Selection using condition type* → *Create*.

Enter condition type PR00.

Choose *Material with release status* as a key combination.

You reach the fast entry screen for conditions.

3. Enter data in the *Sales organization*, *Distribution channel*, and *Material* fields.

Enter the pricing data for the material.

The following figure gives an example of the role of a condition record for a material price.

4. Entry of *calculation type*:

You determine the calculation type for a condition type in Customizing. This determines how the system calculates prices, discounts and surcharges for a condition. When setting up condition records, you can enter a different calculation type than the one in Customizing. At present all available calculation types are permitted. **The field 'Calculation type' can however not be accessed if this field is left empty.** After the data release has been printed, if the field has not been completed manually, the proposal is automatically taken from Customizing. After this it is no longer possible to make manual changes.

If you use different calculation types for what are otherwise the same conditions (for example, percentage, as a fixed amount or quantity-dependent), you do not have to define different condition types in Customizing. You can set a different calculation type when maintaining the individual condition records.

5. If you want to enter a pricing scale, choose *Scales*. If you want to change the default validity period, choose *Validity periods*.
6. Save the condition record.

In the second step, you have the option to *Create with reference*. This lets you select an existing condition record and overwrite the material number with a different material number. This copies the data for the new condition record. You would only use this procedure if you wanted to create identical or similar prices or pricing scales for several materials.

Dynamic Field Check

Dynamic Field Check

Use

When maintaining condition records in Release 4.6A, you can check all of the fields for valid values. If there is a text table for the individual values, these texts can be determined for the individual values. Some fields in the system are purposely not checked however, because it is not necessary (for example, the fields product hierarchy and document number are not checked in the system)

The check can be done using value tables or fixed values in the SAP dictionary. The special check available before, for example, from the customer or product remains unchanged.

This is a dynamic field check because customer specific fields are automatically included in the check. For checking customer-specific fields the fields must be available in the communication structure KOMG and the value tables or fixed values must be maintained in the SAP dictionary. A foreign key check is also possible.

If you want to switch off the check for individual fields or want to configure these fields yourself, the following Business Transaction Events (BTE) are available (transaction FIBF):

- 00503305 Maintaining conditions: Field check
- 00503306 Maintaining conditions: Text determination

Release Procedures

Use

You can use a release procedure, which allows you, for example, to create condition records purely for planning purposes, which are then only taken into consideration after a pricing release. For this release procedure, you can use the **processing** and **release statuses**. You are free to define and use a processing status, although the release status can not be maintained by you directly but results indirectly from your assignment to a processing status.

→ The release status and processing status are only available for the new condition tables (see standard system section). If you also want to use this status for condition records that already exist, you can convert this (see Conversion section).

Release Status

The release status is already set. You can only set a processing status using assignment and selection of a processing status. The following statuses are currently defined:

- released
- blocked
- released for price simulation (this means the creation of a net price list using the report SDNETPR0)
- released for planning (this means planning in CO-PA) and price simulation

→ If several condition records are found at the access with different release statuses, the following priorities apply:

- Pricing:
only for the release status *released*
- Simulation:
first *released for simulation*
then *released for planning and simulation*
then *released*
- Planning:
then *released for planning and simulation*
then *released*

Processing status

You are free to define the processing status. You can define your own processing status in Pricing for Customizing and assign these a fixed release status.

Examples for processing status:

- released

Release Procedures

- first draft
- for approval
- approved department X
- approved department Y
- approved department Z
- approved management

Customer Specific Adaptation

For defining your own processing logics for the processing status, you can use Business Transaction Event *00503303 Maintain Conditions: Transfers*. If you want to, you can define the sequence of the processing status, which must be kept to when defining condition records (transaction VK12).

Working with the agreements

The agreements have a maintainable release status and no processing status. If conditions are assigned to an agreement, the agreement passes the release status on to all related conditions. The related processing status is then set accordingly.



If you have several processing statuses assigned to a release status, the condition record receives the first (alphabetical) suitable entry as a processing status.

The processing status, which the conditions have received indirectly from an agreement via the release status, can only be changed in the case of released agreements.

Standard System:

There are new condition tables and access sequences for using the processing and release status in the standard system.

New Condition Tables for Release 4.6A:

A304 Material (SAP table A004)

A305 Customer/Material (SAP table A005)

A306 Price list type/Currency/Material (SAP table A006)

A307 Customer (SAP table A007, but without the column)

New Access Sequences for Release 4.6A:

PR02 Price with release status (SAP access sequence PR00) with the tables A305, A306 and A304

K304 Material with release status (SAP access sequence K004) with the table A304

K305 Customer/Material (SAP access sequence K005) with the table A305

K307 Customer (SAP access sequence K007) with the table A307

Assignment of access sequences to the previous condition types from Release 4.6A:

- The access sequence PR02 has been assigned to the condition types PR00, PR01 and PRRP.
- The access sequence K304 has been assigned to the condition types K004 and PMIN.
- The access sequence K305 has been assigned to the condition types K005, KA00 and PR02.
- The access sequence K307 has been assigned the condition types K007, KP00, KP01, KP02 and KP03.

Conversion

As the release and processing status are only available for the new condition tables, you have the option of converting all condition records without the release indicator into new condition records with a release indicator.

The report SD_MOVE_A004_TO_A304 is available as an example report for condition tables (for other tables you can copy the report and enter the source and target table in the source text). The run for this report deletes all of the old records and creates new ones with the status *released*.

When starting the report you can restrict the conversion for specific condition types.

Checks are also carried out during the start report. Checks are made, for example, to see whether the old and new condition tables can only be differentiated in the release status and whether they are assigned to the same access sequence. You can find further information on the checks in the report documentation.

Validity Periods

Validity Periods

Use

Condition records for prices, discounts, and surcharges always include a *validity period*. The validity period is defined by a beginning date and an end date. If you do not specify a validity period in a condition record, the system automatically proposes one. The proposed validity period is set in Customizing for Sales.

Condition Records With Different Validity Periods

You can create different condition records (two material prices, for example) that contain the same data, except for the validity period. For example, you can create one condition record for a material price and define the validity period as the entire current calendar year. At the same time, you can create another condition record that partially overlaps the first record. The second record can define, for example, a special sales price for a limited validity period of just one month.

Maintaining Validity Periods

Creating

You can only create new validity periods in the create screen (and only in fast entry). New validity periods cannot be created in the change screen or in the overview detail screen.

When creating, you cannot enter several validity periods at the same time. The first validity period must first be saved. Then you can go on to enter another validity period.

Changing

You have the following options for changing validity periods:

- directly in the overview screen
- directly in the fast entry screen
- in the Change fast entry detail screen
- not in the overview detail screen

Displaying

You can display the validity periods for a condition record in the condition detail screen.

What Happens When Validity Periods Overlap?

Sometimes, when you create a new condition record or when you change the validity period of an existing record, the validity period overlaps the periods of other existing records. The system reacts differently to whole or partial overlapping:

Partial Overlapping of Validity Periods

- There is no system message
- The validity period of the condition record that already exists is adapted



A condition record is created for the whole of the current year:

Validity Periods

01.01. - 31.12.: 20 USD

At a later point, a further condition record is created, that falls within and splits the original condition record:

01.02. -15.02.: 18 USD

The following condition records are now created:

1. 01.01. - 31.01. -20 USD
2. 01.02. - 15.02. -18 USD
3. 16.02. - 31.12. -20 USD



Note that condition records 1 and 3 have the same pricing information. This means that changes to the price of the first record automatically influence the third record and vice versa. 20 USD represents the basic price and 18 USD represents the promotional price.

If this system behavior is not required, then splitting of condition records should be avoided. In the example above, you would have to shorten the year price and then create two independent periods.

Complete Overlapping of Validity Periods

If the old condition record is completely contained in the new condition record, you receive a system message. The message tells you that the old condition record will be deleted if you continue (This message appears when you want to save). You can either stop what you are doing or continue by confirming.

Table Displays

Table Displays

Use

Data for rapid creation of condition records is arranged in table form.

You have the following options for influencing the presentation:

- Change to the column sequence
This is particularly helpful when a table contains a lot of fields and you want to have the most important ones at the beginning.
Position the cursor on the field and move it with the mouse to the required position.
- Change to the column width (until it can no longer be seen).
Position the cursor on the edge of the field and move the mouse until you have the required width.



Every user can define his own view on the data depending on his own individual way of working, whilst saving the settings as presentation variants.

Click on the upper right hand field of the table presentation, to create presentation variants.

An administrator can identify individual fields throughout the system as in the background.

For setting authorizations for table presentations, the authorization object S_ADM_FCD is available in the authorization class BC_A (Basic Administration).

Long Texts in Conditions

Use

You can maintain long texts in the condition records for Pricing and for Agreements (Bonus, Sales deal and Promotion).

These give information, e.g. on the following:

- Information on the condition record system
- Information on licenses
- Information on invalidity



If you wish, long texts in the rebate agreement can also be transferred into documents (e.g. into the credit memo request for a rebate payment and from there into the rebate credit memo).

For texts in Price Conditions, transferring to documents is not supported.

Texts are not copied over when creating condition records with references.

The following text types are set up in the standard system:

- 0001: Opening comments
- 0002: Licenses
- 0003: Closing comments
- 1000: Bonus payment

There are some buttons in the condition record for text maintenance.

In addition you can use an editor for a text type in the detail screen of the condition record, which allows you to create body text.

Customizing

In Customizing for Text Determination you can set up your own text types.

For an agreement type decide which text type should appear in the agreement for maintenance with "Text Edit Control".

When text is transferred from the bonus agreement to the bonus documents, the document pricing procedure 'B3' is set up in the standard system with the text type 1000.

Pricing Scales

Pricing Scales

Use

When you create a condition record for a pricing element, you can define a *pricing scale*. For example, a scale based on quantity can determine that the more a customer orders of a particular product, the lower the price. You can also create condition records with graduated scales. For further information, see [Pricing interval scales \[Page 62\]](#).

Scale Basis

In the standard system, a pricing scale can be based on any of the following criteria:

- Value
- Quantity
- Gross weight
- Net weight
- Volume
- A formula specific to your requirements

The scale basis is defined in Customizing for Sales for each condition type.

Creating Scales

The following procedure explains how to create a pricing scale for, as an example, a material price. You create pricing scales for other condition types in exactly the same way.

To create a pricing scale:

1. Choose *Goto* → *Scales* in the fast-entry screen of the condition record for a material price.
2. Enter a scale quantity and a rate.
3. To save the condition record, choose *Save*.

Specifying Scale Types

In each condition record where you define a scale, you can further specify the *scale type*. The scale type determines whether the scale is a *From-scale* or a *To-scale*. For example, if you specify a *From-scale* that is based on quantity, the scale determines different prices based on different quantities. To change the scale type for a condition record, choose *Goto* → *Details*. Specify the scale type you want to use.

Special Feature of Calculating the Scale Base Value: Group Conditions

In Customizing for Sales, you can define a condition type as a *group condition*. A group condition means, for example, that the system bases a discount on the combined quantities of more than one item in a sales document. The combined quantities may mean that the customer gets a better price than if the items were priced individually.

Pricing with Graduated Scales

Pricing with Graduated Scales

Use

You can maintain condition records with *graduated scales*. Using a graduated scale allows you to price an item for each level of a pricing scale. By comparison, when you use normal scales, the system determines one price depending, for example, on the item quantity; the same price then applies to each unit of the item. With graduated scales, the result is that multiples prices can appear in the pricing screen for an individual item.



The following example shows how this function can be used:

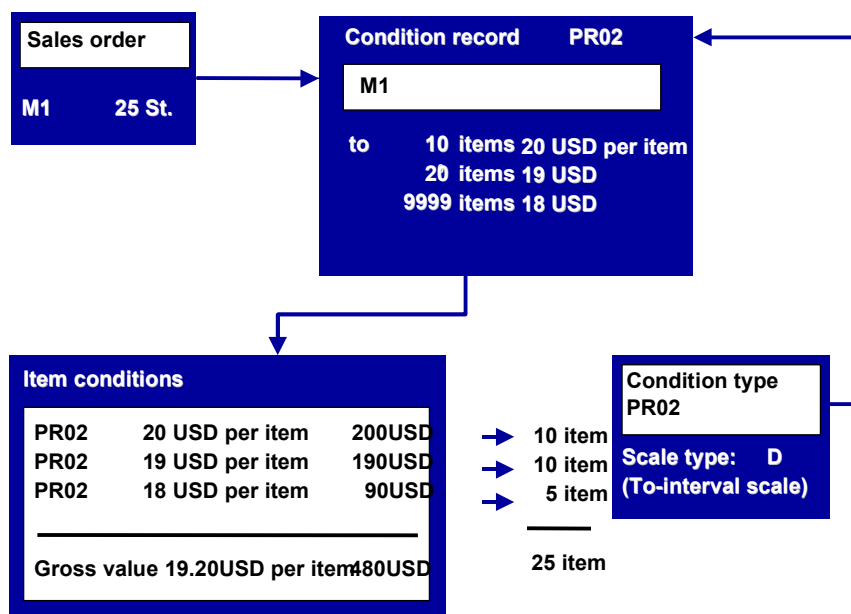

The first PR02 line corresponds to the first 10 pieces, the second line to the next 10 pieces, and the third line to the last five pieces. The subtotal line for the gross value shows the average price per unit for the total number of 25 pieces.

How Graduated Scales are Controlled

The use of graduated scales is controlled in Customizing for SD. The scale type is entered for the definition of a condition type. The standard R/3 System includes condition type PR02 (Price with graduated scale). Depending on the requirements of your business processes, you can modify existing condition types or create new ones that specify graduated prices or discounts.



Graduated scales are used in prices, discounts and surcharges. However you cannot use graduated scales for group conditions.

Condition Supplements

Condition Supplements

Use

A *condition supplement* is a supplement for a particular condition type. For example, you can include a supplement every time you apply a material price. The supplement can contain various discounts. During pricing, the system automatically applies the discounts defined in the supplement every time it accesses a material price. You define the condition types for which you want to use condition supplements in Customizing for Sales.

Including a Condition Supplement in a Condition Record

To include a condition supplement choose:

Goto → *Condition supplement* on the overview screen of the condition record. You can then enter the data for each discount in the condition supplement.



You can only enter a condition supplement if the condition type you are working with has already been defined in Customizing for Sales to include condition supplements.

Default Condition Supplements

You can select a default condition supplement by choosing *Default cond.suppl.* The system automatically proposes all the discounts that are defined for the condition type you are working with. You can then enter the appropriate amounts or percentage discounts that apply to the discounts in the condition supplement.

Condition Supplements

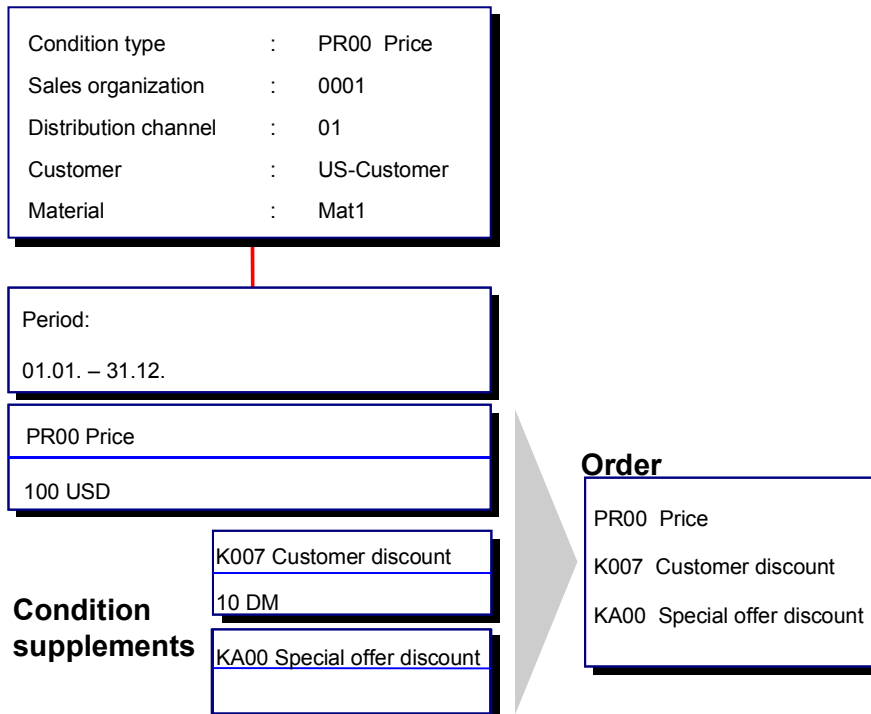

You enter a condition record for the price of the material Mat1 and want to create it so that it is always calculated together with a customer rebate of USD 10 and a special offer discount of 10 %. For every sales order for this material, the system automatically calculates the sales price, the customer rebate, and the special offer discount at the same time.

Condition Exclusion

Condition Exclusion

Use

The system can exclude conditions so that they are not taken into account during pricing in sales documents.



Material 4711 costs 150 USD. Some customers receive a discount of 10 USD per 100 pieces.

However, a specific customer can buy the material for 100 USD. Since this is a particularly good price, the customer should not also have a discount of 10 USD per 100 pieces. Therefore, this discount is to be excluded from pricing.

To do this, you must follow two steps:

1. You must set a condition exclusion indicator for the price. You can do this in two ways:

If you want to set the condition exclusion indicator as follows	then you specify it
for all condition records of a condition type (e.g. with condition type PR00)	when defining a condition type in SD Customizing
for an individual condition record (e.g. only for material 4711)	in the detail screen of a condition record (in the <i>Condition exclusion</i> field)

2. You must set a condition for the discount in the pricing procedure in Customizing for sales. If this condition is set, the discount is not valid if the condition exclusion indicator is set. Condition 2 is available in the standard R/3 System.



The condition exclusion indicator is not valid for condition supplements.

This means that if a condition record contains condition supplements they will be taken into account during pricing.

Upper and Lower Limits

Use

In a condition record, you can define upper and lower limits to restrict manual changes in the sales document during pricing.

Procedure

To specify limits:

On the overview screen of the condition record, select the appropriate condition record and then choose *Goto* → *Details*. The details screen for the condition record is displayed. Here you can maintain the Upper limit and Lower limit fields as required.

If, during manual processing, you exceed or drop below a defined limit, the system informs you with an error message.

Reference Conditions

Reference Conditions

Use

It may be necessary to use different condition types for the same condition. The condition types can differ in access sequence, description, reference level in the pricing procedure or calculation type. In Customizing for Sales, you define a *reference condition type* for this condition type. In this case, you must define the condition records only once for the reference condition type.



Example:

Condition type MWST is defined as reference condition type for condition type MW15. So you must create the condition records only for condition type *MWST* and not for condition type *MW15*.

You can also use condition types in other applications as reference condition types. In this case, you must maintain not only the reference condition type but also the reference application in Customizing for Pricing.

[See also:](#) Implementation Guide, Section Pricing

Changing Condition Records

When there are price changes, you have the option of changing individual condition records manually. Using the price change function, several condition records can be changed automatically. Both procedures are described below.



In the standard system most condition types are configured so that during sales document processing you can overwrite many of the automatically determined condition amounts (in the sales order, for example). However, these changes are only *one-time* changes and do not affect the corresponding condition records. To make lasting changes in automatic pricing, you must change the condition records.

Making Changes in Individual Records

Steps:

To change to a condition record:

1. Choose *Logistics* → *Sales and Distribution* → *Master data*.
2. Choose *Conditions* → *Selection using condition type* → *Change*.

Enter the required condition type.

You reach the screen where you can select the condition record you want to change. You can also select a number of individual condition records which you can then change one after the other.

3. Enter your selection criteria and choose *Execute*.

The system displays a list of the condition records that meet your selection criteria.

4. If a condition record does not include a pricing scale, you can make your changes on this screen. If the condition record does contain a pricing scale, mark the condition record you want to change and choose *Scales*.
5. Enter the changes you want to make.
6. Choose *Save* to save the changes and repeat the process if you want to change further condition records.

Making Automatic Changes

If you want to apply the same price change (for example, a 5% increase) to a number of different condition records, you can make the change globally.

Steps:

To make a global change to more than one condition record:

1. In the initial screen, choose *Logistics* → *Sales and Distribution* → *Master data*.
2. Choose *Conditions* → *Selection using condition type* → *Change*.

Enter the required condition type.

Changing Condition Records

2. Enter your selection criteria and choose *Edit* → *Start selection*.

The system lists the condition records that meet your selection criteria.

3. Select the condition records you want to change and choose *Change amount*.

The system prompts you to enter the change. The price change can be a percentage or a fixed amount. If the change is a fixed amount, you can specify the currency. If the change is a price reduction, you enter a minus sign after the amount. If necessary, you can also specify a rounding rule.

4. Choose *ENTER* to carry out the changes.

The system carries out the changes (including changes to pricing scales) and displays a log of the changes you made.

5. To save the amended condition records, choose *Back* to leave the log and then *Condition* → *Save*.

Change Documents for Condition Records

As of Release 3.0C, change documents for condition records are available. Using the new display report, users can display and monitor all changes made to condition records, including those used in pricing, rebate agreements, and sales deals.

Displaying Change Documents

You can display change documents during condition record maintenance. Just select the condition record or records whose change documents you wish to display.

Steps:

There are two possible methods of displaying change documents:

- Choose *Environment* → *Changes* → *For condition record*.
Change data for the selected condition record(s) will be displayed.
- Choose *Environment* → *Changes* → *Report*.

A selection screen will appear where you can choose multiple criteria for displaying change documents. The result of the selection report is displayed in three hierarchy levels.

Hierarchy Levels in the Selection Report

You can display three levels of data in this hierarchical style report:

- Level 1 data:
Date and time the change was made
Condition type, condition table, and variable key for the condition record changed
Transaction code and user who made the change
Validity period of the condition record at the time the change was made
- Level 2 data:
Description of the change that was made
Old (before) and new (after) values
Name of the field that was changed
- Level 3 data:
Automatic changes made to condition records by the system due to a change in validity period are displayed on the third level. Condition records here have been split from records on the second level and are therefore related.

When a condition record is split into two records due to a change in validity period, it is displayed on the third hierarchy level with the relevant changes.

You display changes in old and new values just as you would for the second level.

Change Documents - Special Features

1. **Changes to validity periods**

Change Documents for Condition Records

When a condition record is created or the validity period of an existing condition record is changed, the system may automatically adjust the validity period of other condition records that have the same variable key. The reason for this is that at any one point in time, only one condition record with a particular condition type and variable key may be valid. All changes that the system makes automatically to existing condition records are displayed in level three of the change document display report.

If the validity period of a new condition lies within the validity period of an existing condition record, the system automatically splits the condition record into three different validity periods.

2. Changes to scales

When condition scales are changed, *all* condition scale entries (not just those that have been changed) are recorded as change documents. In this way, you have a complete overview of condition scales before and after any changes.

3. Changes to condition supplements

The system displays all changes made to condition supplements (including their scales) along with any changes made to the condition record. These changes are identified by the word *Supplement* followed by the condition supplement type changed, and finally, by the description of the change made. For example, if you create the condition supplement KA00, the description would be: "Supplementary condition (KA00): Condition record was created".

Copying Condition Records

Use

The copying function allows you to create multiple condition records at one time. You can either copy one or more existing condition records into new records or you can create a new record and use it as the basis for copying additional records, all in one step. You can copy condition records even when the source and target records have different condition types, condition tables, or key field values. However, copying between different condition types or condition tables is subject to certain prerequisites and rules.

Prerequisites for Copying

The following general prerequisites apply to copying condition records:

- If the condition tables differ between the source and target condition records, then:
 - Only one field may differ between the two condition tables
 - The condition tables must contain the same number of fields
- If the condition types differ between the source and target condition records, then each condition type must have the same calculation rule, scale type, condition class, and plus/minus indicator.

Copying Rules

Copying rules determine which condition types and condition tables you can use for copying between source and target condition records. The rules are defined in Customizing for Sales and must meet the prerequisites listed above. The standard R/3 System contains standard copying rules. If required, your system administrator can modify the standard copying rules or add new ones to meet your requirements. During processing, you can select from alternative copying rules, depending on what you are trying to copy.

Examples of Different Copying Scenarios

The following three scenarios describe how you can copy condition records.

Scenario 1: Same condition types/same condition tables

You offer a special discount to a particular price group (a group of customers defined in the customer master record). You want to make this discount available to other price groups by copying pricing details from the existing record. In this type of copying, the [condition types \[Page 11\]](#) (K020) and the [condition tables \[Page 13\]](#) (table 20) are identical for both source and target condition records. The only thing that varies in this case is the value of one of the key fields (the *Price group* field).

Scenario 2: Same condition types/different condition tables

The [access sequences \[Page 17\]](#) for a particular condition type can be defined in Customizing for Sales so that it accesses more than one condition table. This means condition records with the same condition type can have different keys. You can also copy condition records where the condition type is the same but the condition tables are different. Say you offer a material-specific discount to a particular price group (condition type K032, condition table 32). You can copy this

Copying Condition Records

material discount and create a new condition record for a specific customer (condition type K032, condition table 5).

Scenario 3: Different condition types/different condition tables

You can also copy condition records even when both condition types and condition tables are different. Say you offer a special discount to a particular price group (condition type K020, condition table 20) as you did in the first scenario. Here, however, you want to copy this condition record not to another price group but to a new customer-specific discount (condition type K007, condition table 7). In this case, both condition types and condition tables are different.

Copying Process

You can call up the copy function from the *Edit* menu in any of the following condition record screens:

- Creating
- Creating with reference
- Changing
- Overview

There are several typical scenarios for using the copying function. You may want to copy an existing condition record into a number of new condition records. In this case, you use the change condition record function. Alternatively, you may want to create a new condition record and copy it to other records all in one step. In this case, you use the create condition record function. In both cases, you can change the copied data before you save the new condition records.

See also:

[Copying Condition Records \[Page 75\]](#)

Copying Condition Records

Using the Copy Function

In this example, you have an existing condition record that specifies a material discount for a particular customer. You want to offer the same discount to other customers by copying the data from the existing condition record into new records for each additional customer.

Steps:

To copy the existing condition record into the new records:

1. Choose *Logistics* → *Sales and Distribution* → *Master data*.
2. Choose *Conditions* → *Selection using condition type* → *Change*.
Enter the required condition type.
3. Enter the selection data to select the existing condition record.
The system displays the existing condition record(s) in the fast change screen.
4. Select the condition record that you want to copy and choose *Copy*. If you want to select from alternative copying rules, see [Selecting From Alternative Copying Rules \[Page 76\]](#).
You reach the selection screen. In this example you choose from a list of customers, for whom you would like to copy reference condition record data.
5. Enter your selection data and choose *Execute*.
The system displays a list of the customers who meet your selection criteria.
6. Mark the customers for whom you want to create copies of the reference condition record and choose *Continue*.
The system displays the overview screen for condition records and lists the new condition records you have just created, as well as the existing condition record you used as a reference.
7. In the overview screen, you can change the data for individual condition records by branching to the various views (*Validity periods*, *Condition rate*, *Terms of payment*, and so on).
8. Save the condition records.

Displaying the Copy Log

After you have copied something, the system advises you if there are error messages in the copy log. You can see the log by going to *Extras* → *Copy log condition*. The error messages in the copy log refer to the most recent copy transaction you carried out. With every new copy transaction, the log is automatically updated with only the current data.

Selecting From Alternative Copying Rules

Selecting From Alternative Copying Rules

More than one copy rule may exist during a particular copy procedure. For example, if you are copying an existing condition record for a material price, the standard version includes two possibilities: the target condition record may be either a material or a material pricing group.

Steps:

Choose between alternative copying rules:

1. Choose *Logistics* → *Sales and Distribution* → *Master data*.
2. Choose *Conditions* → *Selection using condition type* → *Change*.
Enter the required condition type.
3. Enter the selection data to select the existing condition record.
The system displays the existing condition record(s) in the fast change screen.
4. Mark the condition record that you want to copy and choose *Edit* → *Copy* → *Select rules*.
The *Copy Condition Rules* dialog box appears.



If you are copying condition records in a [sales promotion \[Page 89\]](#) or from the overview screen and you have selected records with different condition tables, the *Copy Condition Rules* dialog box includes a separate entry for each different condition table. Otherwise, the dialog box contains a single line.

5. To display the copy rules, place the cursor in the *Number* field and choose *Possible entries*.
The system lists the alternative copy rules that have been defined.
6. Select the copy rule that you want to apply.
7. Choose *Continue* to copy the item using the alternative copy rule you selected.

Deleting a Condition Record

Use

There are two possible procedures for deleting conditions. There is either immediate deletion or a deletion flag for archiving at a later date. You enter the type of deletion that should be proposed during condition maintenance into Customizing for a condition type, . When deleting immediately, a dialog box can be created which indicates immediate deletion but offers a deletion flag as an alternative.

Deletion Flag

You can mark condition records for deletion. These are then no longer taken into consideration during automatic pricing. However they remain as condition records in the system until the next archiving update. This means you can reset a deletion and reactivate a condition record.

Physical Deletion

If you use physical deletion, the condition record disappears immediately. It is no longer available during condition record maintenance or pricing. This deletion cannot be reset once it has been carried out. You have to recreate the condition record if you need it again. To be more exact, the reference to the condition record for pricing and condition record maintenance is deleted completely with physical deletion. The actual condition record must be kept for old documents.



Recommendation:

SAP recommends the physical deletion procedure. The deletion flag improves upwards compatibility in the system.

A pricing error can occur when using hierarchical accesses in combination with the deletion indicator (See the hierarchical access documentation in the SAP library).

The deletion flag used to be used as a replacement for a missing release procedure. This is no longer necessary, as there is now a separate release procedure available (see the release procedure in the SAP library).



Physical deletion can be included using the change documents – for example deletions in a specific period (Report RV16ACHD).

Condition Index

Condition Index

Use

You can create and use condition indices. You can use these indices to display, change and create condition records with reference. This transaction can include condition records with several condition types and tables. For example, you can use a condition index if you want to see all condition records that apply to a particular product regardless of whether the records are prices or discounts. In this case, you can use one of the standard condition indexes. Or you may want to see a list of condition records that contain a particular sales deal and a material from a user-specified list of products. To display this information, you can create your own condition index.

Creating an Index

Creating a condition index is similar to creating a condition table. In Customizing for Sales, you select the combination of fields that you want in the index key. The system automatically proposes a list of permitted fields to choose from. The fields you specify for the key can have a maximum combined length of 100 characters. Further information on creating an index can be found in the IMG (Implementation Guide).

Reorganizing an Index

Reorganization means updating an index with current data. The following are examples of when this might be required.

- After you create a new index and generate it, you want to fill the index with the current data in your system. (This also applies if you choose to activate one of the standard condition indexes).
- After you specify that condition indexes should be updated for a particular condition type, you want to fill the indexes with the corresponding condition records that already exist.



Please note that since the system has to read all the relevant condition records, reorganization is automatically submitted as a background task.

Activating an Index

The activation function displays a list of all available condition indexes and indicates which are active. The system can use a condition index only when it is activated. Before you can use the indexes that are delivered in the standard version, you must first activate them in Customizing for Sales. Some indices are activated automatically during generation. In addition, you must specify one of the following index updating requirements for each condition index:

- Requirement 1: The index is updated when the user provides data for all fields in the index
- Requirement 2: The index is updated when the user provides data for at least the first index field

Controlling Index Update by Condition Type

You can specify for each condition type whether or not the system updates the condition indexes when you post condition records. In cases where updating condition indexes may not be

necessary - for example, with freight- and tax-related condition records - you can leave the condition index indicator blank.

Selecting Condition Records Using an Index

After you have defined a condition index and the system has updated it with current data, you can use it to search condition records.

Procedure

To select condition records using an index:

1. Choose *Logistics* → *Sales and Distribution* → *Master Data* from the main menu.
2. Choose *Conditions* → *Select using index* and specify whether you want to change or display condition records.

A dialog box displays the condition indexes that are currently available.

3. Select the condition index you want to use and choose *ENTER*.

You reach the screen where you enter selection criteria.

4. Enter your selection criteria and choose *Execute*.

The system displays a list of the condition records by condition type for the selection criteria you entered.

Special Condition Record Functions

Special Condition Record Functions

Use

Special condition records enable you to store data that is used during special business processes. For example, you can track the number of sales orders that have accessed a particular condition record. This can be useful when you want to track promotional discounts that are based on the number of orders received (for example, a discount that applies to an opening order and the first subsequent fill-up order).

[Terms of payment \[Page 81\]](#)

[Tracking cumulative values with condition update \[Page 82\]](#)

[Maximum value \[Page 83\]](#)

[Maximum quantity \[Page 84\]](#)

[Maximum no. of orders \[Page 85\]](#)

Terms of Payment

Use

You can include terms of payment as part of your promotional strategy. For example, when you create master data for promotions or sales deals, you can specify special values for the following payment-related data:

- Terms of Payment
- Fixed value date
- Additional value days

If you create a sales deal as part of a promotion in which you have already specified special terms of payment, these values are automatically copied into the sales deal. When you create condition records as part of a sales deal in which you have specified special payment terms, the system automatically copies the terms into the condition record.

Terms of Payment During Order Entry

During order entry, the system copies special terms of payment from the condition record into the sales order. The terms in the condition record have priority.



If a sales order includes items with terms of payment that differ, the system automatically generates split invoices during billing.

Tracking Cumulative Values With Condition Update

Tracking Cumulative Values With Condition Update

Use

Special offers and discounts to customers are frequently offered as part of a sales promotion based on accumulated sales order data. For example, when your customers place orders for a new product, you may offer them an introductory allowance up to a specified total value (for example, up to USD 5,000). As a customer places orders for the new product, the system must be able to keep track of the cumulative discount total. With Release 2.1, it was possible to accumulate values based on invoices for the purpose of processing rebate agreements. In Release 2.2 this idea was extended to include a new, more general *condition update* function.

Controlling Condition Update

Condition update is controlled by the condition type in setting Customizing for Sales. If you set the condition update for a particular condition type, the system subsequently updates the corresponding condition records whenever you process relevant sales and billing documents.

Pricing Function Support

Condition update provides the basis for the following pricing functions:

- Maximum Value
- Maximum quantity
- Maximum Number of Sales Orders

These functions are described in more detail in the following section:

Maximum Values

Use

Provided that the condition update function is active for a particular condition type, you can create condition records that specify a maximum cumulative value. The system uses the condition value of an item as the basis for the cumulative value.



You can specify, for example, that a customer receives a 2% discount for a particular item up to a maximum cumulative discount value of USD 1,000. As the customer places sales orders for the item, the system keeps track of the cumulative discount value and stores this data at condition record level. Once the cumulative discount value reaches USD 1,000, the system automatically deactivates the discount.

Specifying Maximum Value

You can specify the maximum value when you create a new record or you can maintain an existing condition record. The condition update indicator must be maintained in Customizing for Sales for the corresponding condition types.

To specify the maximum value:

1. Choose *Logistics* → *Sales and Distribution* → *Master data*.
You reach the *Sales Master Data* screen.
2. Choose *Conditions* and select the condition record you want to work with.
3. Within the condition record, choose *Additional sales data*.
4. Enter the maximum value in the *Maximum condition value* field.
5. Choose **Back** to return to the overview screen of the condition record or save your work.

Viewing Update Data in the Condition Record

To view the cumulative value for a particular condition record:

1. Within the condition record, choose *Extras* → *Cumulative values*.
A dialog box displays the cumulative value of sales orders where this condition record was used.
2. Within the dialog box, you can branch to the cumulative value of related billing documents or to a list of the latest sales orders. You can also branch to the individual sales orders.

Maximum Quantities

Maximum Quantities

Use

If the condition update function is active for a particular condition type, you can create condition records that specify a maximum cumulative quantity. The system uses the condition base value of an item as the basis for the cumulative quantity. In most cases for the condition base, this involves a quantity. It is also possible to enter maximum quantities in weight and volume for a condition record.



You could, for example, specify that a customer receives a 10 USD discount for a particular material up to a maximum cumulative order quantity of 5,000 cases. As the customer places sales orders for the item, the system keeps track of the cumulative value (in this example, the number of cases) and stores this data at the condition record level. Once the cumulative value reaches 5,000 cases, the system automatically deactivates the discount.

Specifying the Maximum Quantity

You can specify the maximum quantity when you maintain an existing condition record. The calculation type of the respective condition type must be defined as quantity, weight, or volume dependent (otherwise the necessary field will not appear in the condition record). The condition update indicator must be maintained in Customizing for Sales for the corresponding condition types.

To specify the maximum quantity:

1. Choose *Logistics* → *Sales and Distribution* → *Master data*.
You reach the *Sales Master Data* screen.
2. Choose *Conditions* and select the condition record you want to work with.
3. Within the condition record, choose *Additional sales data*.
4. Enter the maximum quantity in the *Maximum condition base value* field.
5. Choose *Back* to return to the overview screen of the condition record or save your work.

Viewing Update Data in the Condition Record

To view the cumulative quantity (condition basis) for a particular condition record:

1. Within the condition record, choose *Extras* → *Cumulative values*.
A dialog box displays the cumulative base value (in this case, the quantity) of sales orders where this condition record was used.
2. Within the dialog box, you can branch to the cumulative value of related billing documents or to a list of the latest sales orders. You can also branch to the individual sales orders.

Maximum Number of Sales Orders

Use

You can specify the maximum number of orders in a condition record. For example, you offer your customers a special discount on a new product. You want the discount to count for the introductory order and for one refill order. The system keeps track of the number of orders the customer places and, after the maximum number is reached, automatically deactivates the condition record. After deactivation the condition type no longer appears on the pricing screen in the order. In addition, the system automatically stores statistical data for condition records where a maximum number of orders is specified.

Specifying the Maximum Number of Orders

You can specify the maximum number of orders (up to a maximum of three) in the condition record. The condition update indicator must be maintained in Customizing for Sales for the corresponding condition types.

To specify the maximum number of orders:

1. Choose *Logistics* → *Sales and Distribution* → *Master data*.
You reach the *Sales Master Data* screen.
2. Choose *Conditions* and select the condition record you want to work with.
3. Within the condition record, choose *Additional sales data*.
4. Enter the maximum number in the *Maximum number of orders* field.
5. Choose *Back* to return to the overview screen of the condition record or save your work.

Viewing Update Data in the Condition Record

To view the orders in which the condition record was used to date:

1. Within the condition record, choose *Extras* → *Cumulative values*.
A dialog box displays the cumulative base value (in this case, the quantity) of sales orders where this condition record was used.
2. Choose *First Orders*.
You can display a list of the first orders (maximum three).

Special Pricing Functions

Promotional Pricing Agreements

There are two types of agreements for carrying out marketing programs with wide-ranging discount structures: promotions and sales deals.

Promotions

A *promotion* typically represents a high-level marketing plan for particular products or product lines - for example, a promotion for a range of products during a specific sales cycle. A promotion can include a number of different sales deals. For example, if your promotion covers a range of different product lines, you can create separate sales deals for each product line.

Sales Deals

Sales deals provide a finer focus for your promotional activities. In the example above, a promotion includes separate sales deals for each product line. Within the sales deal for a product line you might want to be able to promote the products in different ways. You might, for example, want to offer customer-specific discounts in some cases and material-based discounts in others. You can then create specific condition records that are linked to the sales deal, or assign existing condition records. If the sales deal is linked to a promotion, the condition record also contains the number of the promotion. This makes it possible later on, for example, to list and analyze all the condition records that refer to a particular promotion.

Defining Agreement Types

Before you can enter promotions and sales deals as master data in the system, you must first define the types of agreements that you want to use. You define types of promotions and sales deals in Customizing for Pricing in the section on pricing agreements in exactly the same way as you define types of rebate agreements. For example, you can specify the number range which is to be used to assign identifying numbers to sales deals of a particular type. You might do this to distinguish between different product groups.

For each type of agreement that you set up, you can specify the following data:

- Number ranges (internal and external) from which the identifying numbers for the agreements are taken
- Condition types and condition tables that can be used in the agreement type
- Which overview screen the user sees when creating master data
- Which validity period is proposed as a default value
- Additional control data for the condition types that can be used for the agreement

Creating Master Data for Agreements

After you define the types of promotions and sales deals you want to use, you can enter the master data in the system. For each agreement you create you can specify general data. In the case of sales deals, you can also create the individual condition records.

General data

The general data you define applies to all subsequent condition records that you create for the agreement. Each agreement that you create is identified by a unique 10-digit number. Depending

Promotional Pricing Agreements

on how you define the agreement type, the system either assigns the number automatically or you enter a number manually. In addition, you can enter the following data for each agreement:

- Short text description of the agreement
- Validity period
- Special payment-related data:
 - Terms of payment
 - Fixed value date
 - Additional value days

Creating Promotions and Sales Deals

Steps:

You create promotions and sales deals in the same way. To create a new sales deal:

1. Choose *Logistics* → *Sales/distribution* → *Master data* in the main menu screen.
You reach the *Sales Master Data* screen.
2. Choose *Agreements* → *Sales deal* → *Create*.
You reach the *Create Sales Deal* screen.
3. Enter a sales deal type (for example, 0101) and choose *Continue*.
The *Overview Agreement* screen will appear. The system will propose a validity period.
4. Enter the optional data, such as:
 - Short description of the sales deal
 - An external reference (from the customer)
 - The number of the promotion, if any, to which the sales deal is assigned
 - Special payment terms



If you assign the sales deal to a promotion, the system proposes any special payment terms that you have defined for the promotion.

5. If you do not want to create condition records for the sales deal at this time, save your data. If you want to create condition records immediately, go to the next procedure.

Creating Condition Records Within a Sales Deal

Creating Condition Records Within a Sales Deal

You can create condition records for a sales deal in the following ways:

- At the same time as you enter the master data for the sales deal in the system. (In this case, the system automatically creates the link between the condition records and the specific sales deal.)
- By creating a new sales deal with reference to an existing sales deal and copying some or all of the condition records over
- By adding new condition records into an existing sales deal. (In this case, you enter the number of the sales deal manually.)
- By copying existing condition records into a sales deal you have already created.

For further information about copying condition records, see [Copying Condition Records \[Page 75\]](#).

Steps:

To create condition records directly from within a sales deal:

1. Choose *Pricing* in the overview screen of the sales deal.
The system displays a list of valid condition types for this type of sales deal.
2. Select the condition type for which you want to create a condition record and enter your data.
3. If you want to create additional condition records for the sales deal, choose `Back` to return.
The system returns you to the dialog box that lists the valid condition types you can use.
4. After you have created the condition records you want, choose `Back` and save your data.

Release Status

Use

The release status for condition records in a sales deal enables you to limit the use of records that have already been created.

Release status has the following characteristics:

- no entry: released
- A: blocked
- B: released for price simulation
- C: released for price simulation and planning

The amount and significance of individual characteristics is defined using domain fixed values and can not be maintained.

Maintenance of the release status is carried out in the sales deal itself (in the proposed values block), is transferred over to the condition records concerned and can then not be changed for these records.

When setting up a new sales deal (with copy), a proposed value is suggested for the release status, which can be set up in Customizing for the agreement type.

A record blocked for an application is treated in the access, as though it has been identified with a deletion indicator. It can however be recognized and displayed as such via the log functionality in Pricing.

The characteristic Pricing Simulation is only used in the report SDNETPRO, which gives a net price list.

If when maintaining individual condition records a sales deal is assigned to the condition record using the transaction VK12, the release status from the sales deal is used for this record. When changing the release status using this sales deal or changes to the sales deal, the user will be notified of any changes to the status.

The release status of conditions in an agreement can only be changed, if

- the condition record has release status in the key
- the agreement has the release status *released*

Otherwise the condition record always has the release status of the agreement.

The processing status is always directly assigned to a release status. If conditions are assigned to an agreement, the agreement passes the release status on to all related conditions. The related processing status is then set accordingly.



If you have several processing statuses assigned to a release status, the condition record receives the first (alphabetical) suitable entry as a processing status.

The processing status, which the conditions have received indirectly from an agreement via the release status, can only be changed in the case of released agreements.

Release Status

Budget Assignment

Use

During market segment planning and sales and profit planning, you can create budgets for sales support measures (e.g. sales promotions) and related special offer discounts. This budget is then used in the sales and distribution system (SD) when conditions (special offer discounts) are maintained for the customer agreement. You can monitor the budgeting process from assignments within the customer agreement to the billing document in CO-PA. This is because the budget assignments are transferred to CO-PA when you maintain the conditions.

You can keep checking the budget assignments by carrying out variance analyses of the planned and available budget. This allows you to monitor sales promotions in detail right from the early stages of profitability analysis.

Process Flow

The process flow for SD-promotion budgets withing sales and profitability planning could appear as follows:

1. In sales and profitability planning you can create budgets for individual sales support measures.
2. Budget assignmets are created in SD for the conditions to be granted for the customer agreements.
3. In reporting, you can control the availability of funds for sales promotion by market segment.
4. The data flow at the points of "condition maintenance", "create sales order" and "billing document" makes it possible to carry out reporting in the profitability analysis with maximum precision all along the business process chain.
5. Based on the planned structure, you can use a hierarchical representation to specify the market segments for which budgets can be created. This ensures consistency during planning, because budgets can then only be created in the allowed market segments.

Budget Assignment in SD

Budget Assignment in SD

Working with sale promotion and SD budgets can be split up into three stages:

1. Budget planning in CO-PA
2. Budget assignments in SD (condition record maintenance)
3. Passive availability check in CO-PA

Prerequisites

You must activate transferal of assignments to CO-PA per condition type. You carry this out in Customizing for CO-PA, under *Flow of actual values* → *Transfer of sales agreements*.

Activities

1. Budget planning in CO-PA

A budget is planned within manual planning. You can use several planning functions to help you carry out manual planning. It is a good idea if you define your own plan version for a budget.

2. Budget assignments in SD (condition record maintenance)

Budget assignments can be made during condition record maintenance, as well as within sales promotions, sales deals and rebate agreements.

To maintain a budget assignment, select *Logistics* → *Sales and distribution* → *Master data*. Under *Agreements*, select either *Rebate agreements*, *Promotion* or *Sales deal*. Go to the condition screen for the required condition and display the detail screen for the required characteristic.

This is where you enter the *Condition amount* and the *Planned basis*. The system uses this to calculate the value that is filled in the relevant field in CO-PA.

Rule	Condition type	Planned basis
A	percentage	planned sales volume
B	fixed amount	
C	quantity-dependent	planned quantity
etc.		



You want to maintain a budget assignment, in which you grant a price reduction of 20% of the planned sales revenue of 100,000 USD for material A1.

In SD sales deal maintenance, you select the condition screen for the 'price reduction' screen. You then select the detail screen for material A1. Calculation rule 'A' - *percentage* is maintained. You enter 20 in the condition amount field and 100,000 in the planned basis field. Save your entries.

Budget Assignment in SD

The system automatically calculates a planned value of 20,000 USD. This value is transferred (according to value field assignment) to the corresponding value field in CO-PA 'Sales deductions'.



You can also maintain the planned values for all conditions in an agreement. You do this in the overview. In the agreement, select: *Goto* → *Overview* → *Planned values*.

3. Passive availability check in CO-PA

Using reporting in CO-PA, you can carry out a passive availability check. During this check, the planned version in which the budget was planned (in manual planning) is compared with the assignments from SD (via transaction type G).

Using Variable Views of Condition Record Data

Using Variable Views of Condition Record Data

Use

The functions for maintaining condition records have been extended to include variable views. This means, for example, that condition record maintenance is no longer limited to just one condition type and condition table. The screen that presents the variable views is organized in three parts:

- Static data
- Dynamic data
- Dynamic push buttons

Static Data

The static part of the screen consists of the condition type and fields that make up the condition table key.

Dynamic Data

The screen also contains a dynamic part where the data changes according to the view you select.

The standard version includes the following sample views:

- Sales deal
- Administrative data (creator and creation date)
- Condition amount
- Terms of payment
- Validity period

In addition, you can create your own variable screen in Customizing using the data fields you want. Users can maintain data in the fields in the dynamic part of the screen.

Dynamic Push Buttons

You use the dynamic push buttons to select a particular view of the condition record data. In addition to the push buttons in the standard version, you can define your own buttons in Customizing according to the data you want to view.

Selecting Variable Views of Condition Records

Steps:

To select the variable views of condition record data:

1. Choose *Logistics* → *Sales/distribution* → *Master data* in the main menu screen.
You reach the *Sales Master Data* screen.
2. Choose *Conditions* and select the change or display mode for the type of condition record (price, discount, surcharge) you want to work with.
You reach the selection screen for the condition records.
3. Enter your selection data and choose `Execute`.
The system displays a list of the condition records which meet your selection criteria.
4. Choose *Goto* → *Overview* → *Condition Records*.
You reach the condition record overview screen.
5. Choose one of the dynamic push-buttons at the bottom of the screen.

Additional Functions

You can branch into individual records to display or change them. You can also select records for collective change. For example, you can select a number of records and change the validity period for all the selected records in one step.

Customer Expected Price

Customer Expected Price

Use

Resolving disputed invoices costs some industries (for example, the consumer packaged goods industry) a great deal of time and money. Customers deduct disputed invoices from payments and staff members spend valuable time investigating and researching the reasons for the disputed payment. In addition, prolonged disputes can endanger supplier-customer relations. The extended pricing functions introduced in Release 2.2 enable you to take into account the customer's expected price. By entering the expected price during sales order processing and comparing it with your price, you can help avoid disputed invoices later.

During Order Entry

You can enter customer expected price data manually during order entry in the double-line overview screen of the sales order. Alternatively, you can enter the expected price data directly in the pricing screen, using one of two new condition types:

Condition type	Description
EDI1	Customer expected price
EDI2	Customer expected value

System Reaction to Price Variation

If, during order entry, the expected price and the actual price differ beyond a specified amount (according to the formula you specify in the pricing procedure), the system assigns an incompleteness status to the order. The sales order cannot be processed for delivery or billing until the discrepancy is resolved.

Controlled Through Pricing Procedure

You control customer expected price functionality in the pricing procedure in Customizing for Sales. The pricing procedure must include the new condition types, EDI1 and EDI2. In addition you can specify a formula for each condition type. The formula enables you to specify different criteria for comparing expected and actual prices. The standard R/3 System includes two formulas:

Formula	Expected price may not deviate over...
8	expected price may not vary more than 1.00 of the currency unit
9	expected price may not vary more than 0.05 of the currency unit

You specify the formula in the *Alternative calculation type* field of your pricing procedure.



In addition, you can modify the standard formulas or create your own. For more information about working with formulas, see the online Implementation Guide.

Processing Sales Orders With Customer Expected Price

The following procedures show you how the customer expected price is entered during sales order processing and also how to process sales orders in which discrepancies between expected price and actual price have occurred.

[Entering Customer Expected Price in the Sales Order \[Page 100\]](#)

[Processing Lists of Orders With Price Discrepancies \[Page 101\]](#)

Entering Customer Expected Price in the Sales Order

Entering Customer Expected Price in the Sales Order

Steps:

To enter a customer's expected price in a sales order:

1. Within the sales order, choose *Overview* → *Double-line entry*.

You reach the double-line entry overview screen.

2. If the customer-expected price refers to the net price per item, enter **ED11** in the *Condition type* field and the price in the *Rate* field.

If the customer expected price refers to the value of the item (net price times quantity), enter **ED12** in the *Condition type* field and the value in the *Rate* field. The data you enter appears as a new line in the pricing screen.

If the customer expected price varies from the automatically determined net price or value, the system marks the sales order as incomplete.

3. Either resolve the price discrepancy in the sales order or save the order as an incomplete document for processing later.

Processing Lists of Orders With Price Discrepancies

Depending on your sales order entry policy, you may want specialized staff to process sales orders with price discrepancies. In this case, you can create work lists of incomplete documents after order entry.

Steps:

To create a list of incomplete documents where the price varies from the customer expected price:

1. In the initial screen, choose *Logistics* → *Sales/distribution* → *Sales*.
You reach the *Sales* screen.
2. Choose *Order* → *Release CustExpPrice*.
You reach the screen where you can enter selection criteria for your list.
3. Enter your selection criteria and choose *Execute*.
The system displays a list of incomplete documents that match your selection criteria. The list includes overview information for each document, such as the customer expected price and the net price.
4. If you want to release sales orders directly from the list, mark the documents and choose *Release*.
The system assigns a status indicator to each released document in the list.
5. If you want to make changes to pricing in a sales order, mark the document, then choose *Environment* → *Document*.
You reach the respective document.
6. After you have finished processing documents in the list, save your work.
The system displays a summary of the released documents with their status.

Cost

Cost

Use

In Pricing, you may want to compare the prices with costs or even implement contribution margin accounting.

To do this, you can use the condition type **VPRS** as the cost price.

The condition type **VPRS** goes into the valuation segment in the material master and determines from this the standard price or average price.

Settings in Customizing

- The condition type **VPRS** is labeled as a statistical condition in the pricing procedure.
- Using the condition category **G**, the condition type **VPRS** goes into the valuation segment of the material master and determines from here the standard or average price.
- The condition category **S** always accesses the standard price whereas condition category **T** always accesses the average price.
- The profit margin is determined using the calculation formula 11 assigned in the pricing procedure. In this calculation formula the cost price is subtracted from the subtotal of net value 2.



For Pricing, the costs from a calculation can also be determined:

[Sales order calculation for pricing \[Page 110\]](#)

For a third-party business transaction, the costs are determined from the purchase order:

[Cost \[Ext.\]](#)

Gross Prices

Use

The gross price is relevant when selling goods to an end customer.

The pricing procedure RVAB02 is available as a reference for these sales processes.

➡ The pricing procedure RVABB02 is, however, so flexible that it can also be used for a net price calculation. This means that you don't have to maintain condition records twice.

Features

The pricing procedure RVAB02 has the following functions:

- Entry of gross prices and discounts
- Separate transfer of the new prices and discounts into the profitability analysis
- Determination of net prices from gross prices for customers not subject to tax

Structure of the pricing procedure

The pricing procedure RVAB02 is divided into the following areas:

- Prices:
 - Gross price determination (condition type PR01) or gross price entry (PB00)
 - Displaying the gross price in a subtotal
- Discounts
 - Gross discount determination and entry
 - Displaying the cumulated discounts in a subtotal
- Taxes:
 - Determination of tax amount, contained in the price (condition type MWI1)
 - Determination of tax amount, contained in the discounts (condition type MWI2)
 - Determination of the whole tax amount (condition type MWIS in the case of a gross sale)
- Net prices and discounts
 - Option of transferring net prices and discounts into the profitability analysis separately
- Rounding correction
 - The correction with the condition type NETD is necessary, as there may be differences between the total of MWI1+MWI2 and MWIS.

Net sale

In the case of a net sale (customer not taxable or foreign business), the condition type MWIG is used instead of MWIS. A net goods value is determined. If you wish to, you can calculate tax on the net value (condition type VAT)

Gross Prices

- ➡ Requirements 70 and 71 in the pricing procedure control whether a sale is net or gross. The requirements take into account things such as the customer tax code and the departure country and destination country.
- ➡ You may want to print out different lines for the net and gross sales. Different subtotals have been set up for this in the pricing procedure RVAB02 with requirements 70 and 71.
- ➡ You can copy the pricing procedure RVAB02 and enhance it.

Condition Exclusion

Use

In pricing for sales and billing documents, more than one condition record may apply to a particular item at any one time. You can use the condition exclusion process to compare possible conditions in order to determine such things as the best price for a customer.

The Condition Exclusion Procedure

First of all, you create exclusion groups. An *exclusion group* is a list of condition types that is identified by a three-digit number. Exclusion groups are defined in Customizing for Sales. You also assign exclusion groups to a pricing procedure and to determine how the condition exclusion is to be carried out.

You then assign the exclusion groups to a pricing procedure, thus defining the condition exclusion.

Depending on how you configure exclusion groups in the pricing procedure, the system can use condition exclusion to select the best price or discount in six different ways:

- Selecting the best condition record of a particular condition type from within one exclusion group
- Selecting the most unsuitable condition from within one exclusion group
- Selecting the best condition record for a condition type
- Selecting the most unsuitable condition record for a condition type
- Selecting the best conditions from different exclusion groups
- Excluding all condition types in the second exclusion group if a particular condition type in the first exclusion group exists in the document

Determining Best Price From Condition Types

During automatic pricing for a sales order item, the system may find a number of valid condition records that apply to the same item. If the competing condition records belong to a variety of condition types, the system selects the record with the best price and excludes the other condition records. Condition records that the system ignores are not deleted from the sales order but are simply deactivated. You can still see the excluded condition records on the pricing screen in the sales order.



In condition exclusion in the standard system, a condition record with a zero value is not taken into consideration. It is treated as though it doesn't exist.

If you want to take a zero value into consideration, enter the standard calculation formula 038 in the pricing procedure for one of the conditions to be compared.

The following is an example of a situation where a zero value should be taken into consideration:

A company has two condition types in the pricing procedure for surcharges. A condition exclusion group with these two condition types has been defined and shows that the lower of the two should be applied. In some cases the surcharge could be zero. The reason for this may be a condition record found or a manual entry. In order that the system takes zero into consideration

Condition Exclusion

as the lowest surcharge for the customer, the formula '38' must be assigned to one of the condition types in the pricing procedure.

Determining Best Price Within One Condition Type

If the access sequence for a particular condition type does not specify exclusive accesses, it is possible for the competing condition records to exist within the same condition type. For example, the system may find two valid condition records for a material discount (K004) - one a material discount, the other a customer-specific material discount. The system determines the record with the most favorable discount for the customer.



If the *Exclusive access* indicator is set, the system looks no further after it finds the first valid condition record. In this case, the system cannot determine a best price.

Determining Best Price from Different Exclusion Groups

This method allows the system to check between exclusion groups for the most favorable price or discount. In this case, the system totals the condition values for each group, compares them, then selects the most advantageous group for the customer.

Excluding the Conditions in an Exclusion Group

In the fourth alternative when the system selects one particular condition type that exists in the first exclusion group, it excludes all the conditions in the second exclusion group from pricing.

After you have defined the exclusion groups you want to use, you can enter them in the pricing procedure. The following example shows how exclusion groups can be used in the pricing procedure. In this case, the exclusion procedure selected is the best condition type within one exclusion group.

Pricing procedure	Exclusion group	Condition type
RVAA01	001	KA00 Sales promotion
RVAA01	001	K005 Customer/Material
RVAA01	002	KF00 Freight
RVAA01	002	KF01 Freight
RVAA01	002	KF02 Freight



You process a sales order item to which the following condition records apply:

Condition type	Rate	Value	Currency
PR00	100 USD/KI	100	USD
KA00	20%	20	USD

Condition Exclusion

K005	10%	10	USD
KF01	1 USD/KI	1	USD
KF02	2 USD/KI	2	USD

In this example, exclusion group 001 deactivates condition type K005. (The system determines that the KA00 condition record is the best discount and ignores the other condition types defined in the group.) Exclusion group 002 deactivates condition type KF02 for the same reason. (The system determines that the KF01 condition record has the lowest freight cost and ignores the other condition types defined in the group.) The final price in this example is calculated this way:

$$100 \text{ USD} - 20 \text{ USD} + 1 \text{ USD} = 81 \text{ USD/KI}$$

Further Information

For further information on defining exclusion groups in Customizing for sales and distribution see the online implementation guide.

Variant Conditions

Variant Conditions

Definition

You can use variant conditions to influence the price of a configurable material depending on the characteristic values assigned.

Use

You can use variant conditions in Sales and Distribution and Purchasing to define surcharges and discounts for the basic price.

Structure

Variant conditions consist of a variant key and an amount that is identified by the variant key.

Minimum Order Value

Use

You can specify a minimum order value for sales order processing. The following example illustrates how this function is used:

- You specify a minimum order value of USD 200.
- During sales order processing, the net value (after discounts and freight, before taxes) of an incoming order is USD 190.08.
- During pricing, the system determines that the net value falls below the minimum order value and calculates a minimum-order-value surcharge. In this example, the surcharge equals USD 9.92.
- The minimum order value and the surcharge appear as separate lines in the pricing screen. The minimum value is for information purposes only, and does not affect pricing. The system automatically adjusts the net value of the order (before taxes) to the minimum value allowed.

Condition Types for Minimum Order Value

The standard R/3 System includes two condition types for processing minimum value requirements:

Condition type	Name
AMIW	Minimum order value
AMIZ	Minimum value proposal

Creating Condition Records for Minimum Order Value

If you use minimum-order-value requirements, you must create condition records for condition type AMIW. In these condition records, you specify customers and the corresponding minimum order values. During pricing, the system automatically uses these condition records as a reference for determining the relevant minimum order surcharges (condition type AMIZ). In the standard version, condition type AMIZ refers to AMIW. This means that the system automatically calculates values for AMIZ conditions; you do not need to create separate condition records.



You may want to specify minimum order values by sales organization or division instead of by customer. In order to do this, your system administrator must define a new condition table with the appropriate fields in the table key. The condition table can then be included in the access sequence for condition type AMIW.

Sales Order Costing in Pricing

Sales Order Costing in Pricing

Use

You can carry out costing for a sales document item (item in an inquiry, quotation or an order) to find out the planned costs for this item. This is called sales order costing.

Sales order costing can be carried out using the following methods:

- Product costing

Product costing calculates the cost of the sales order item on the basis of the sales order BOM. A sales order BOM could be part of a super BOM and the configuration object dependencies.

- Unit costing

Unit costing is used if the system cannot access a sales order BOM. You enter the items to be costed manually in unit costing.

The system determines the prices of the materials and services involved according to the valuation variants saved in the costing variant.

You can use sales order costing to determine the manufacturing costs and total production costs of a material managed as sales stock. As well as the direct material costs and the direct costs of production, you can also determine material overhead costs, production overhead costs, distribution and administration costs or transportation and insurance costs.

Sales order costing is controlled mainly via the costing variant. The costing variant is stored in the requirements class as a proposal value. In the requirements class, you also store the costing method and the costing sheet.

Copying Sales Order Costing to the SD Conditions

You can copy the results of sales order costing to the SD conditions. Copying can be carried out:

- as a basis for pricing

If you want to use sales order costing as a basis for pricing in SD, you can use the standard SAP condition type EK01.

- at a statistical level

You can copy sales order costing at a statistical level, if you do not wish to determine the price on the basis of this costing, but you wish to use the costs determined to calculate the profit margin in SD. EK02 is the condition type provided for this in the standard system.

You can save the condition type in the sales and distribution document type. If you want to define the condition type with reference to the sales document item, then you can also save the condition type in the requirements class.

In the requirements class, you can also store a condition type for the transfer of the fixed costs proportion of the planned costs. EK03 is the condition provided for this in the standard system.

Sales Order Costing in Pricing

For further information on sales order costing, see:

[Sales order costing \[Ext.\]](#)

For more information on Customizing for sales order costing, see the online Implementation Guide.

Controlling → Product Cost Controlling → Cost Object Controlling → Product Cost by Sales Order → Control of Sales-Order-Related Controlling and Preliminary Costing

Duplicating Conditions

Duplicating Conditions

Use

In the standard system, you can use condition type DUPL, which is copied during pricing to all of the sub-items assigned to the item.

For this reason, it only makes sense to use duplicated conditions for bills of materials and configurable materials.



A duplicated condition of 10% is specified for material 4711. The material has components 4712 and 4713. During pricing in the sales order, the duplicated condition of 10% is displayed in components 4712 and 4713.

Constraints

- There are several limitations to duplicated conditions: Duplicated conditions can only be percentage rate conditions.
- Duplicated conditions cannot be used as header conditions.
- The condition value of a duplicated condition cannot be changed manually in the pricing screen.
- When you copy a sales document to a billing document, the condition rate of a duplicated condition is frozen. This means that the condition is not redetermined when it is copied regardless of the pricing type.

Cumulating Conditions

Use

The standard system condition type KUMU enables you to display the total of the net values of an item and all the sub-items belonging to that item.



Item	Main item	Item net value	Net value
0010		0,00	355,00
0020	0010	100,00	320,00
0030	0010	35,00	35,00
0040	0020	80,00	80,00
0050	0020	140,00	140,00

Constraints

- Cumulative conditions cannot be used as header conditions.
- Cumulative conditions cannot be processed manually.
- When you copy a sales document to a billing document, the condition rate and the condition value of a cumulative condition is 'frozen'. This means that the condition is not redetermined when it is copied regardless of the pricing type. The net value of the total is not redetermined even if the individual net values have changed.

Group Conditions

Group Conditions

Use

You want some conditions to be used as the basis for determining scale values from several items.



You have assigned materials to a material pricing group. You want a quantity-based discount to be assigned to these materials. You want the quantity scale to be read cumulatively with the cumulated quantity of all materials in the sales order that are assigned to this material pricing group:

Condition record with reference to a material pricing group:

From 1	KG	- 2,-USD / KG
From 100	KG	- 4,-USD / KG
From 500	KG	- 6,-USD / KG

Pricing in the order for two materials from the material pricing group:

Item 10	Material 1	60 KG	-20,- USD discount
Item 20	Material 2	70 KG	-20,- USD discount

Group Conditions

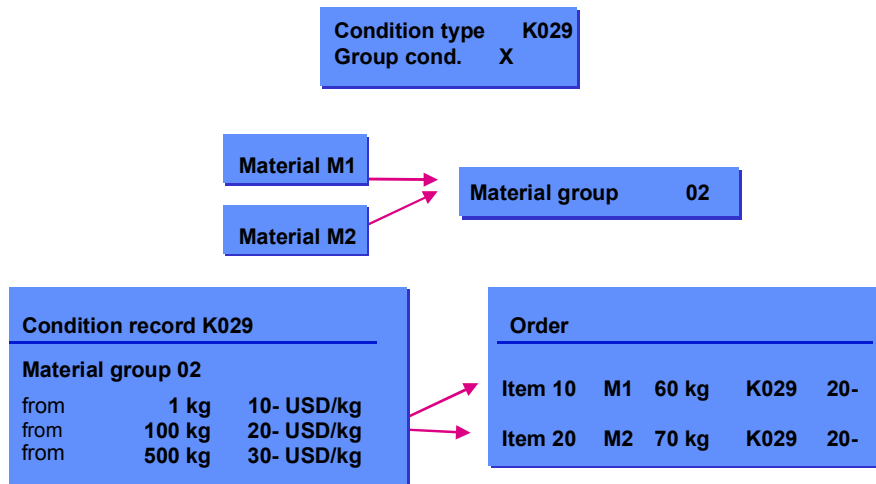

Prerequisites

You must mark the condition type as a group condition in Customizing

If you want the system to carry out cumulation across all items, but to read a separate condition record with this cumulated quantity for each item, you must make the following additional entries for the condition type:

- Quantity unit for cumulation
- Group key number

Group Conditions with Different Key

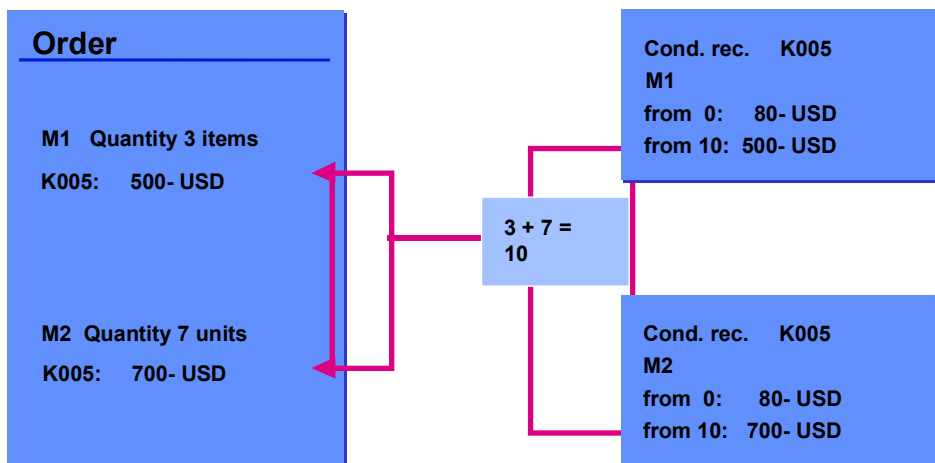

Pallet Discounts

Pallet Discounts

Use

The pallet discounts should make it possible for you to assign conditions for whole units of measure only. There are the following requirements:

- Surcharges and discounts should be calculated.
- Quantities should be cumulated for all items.

There are condition types available in the standard system for the different requirements. These will be explained later on using examples.

Condition Type KP00

- The aim of the pallet discount is to give a discount only for whole units, e.g. whole pallets.
- This is controlled using the base value calculation formula 22 from the pricing procedure, after the total amount of quantities has been taken into account.

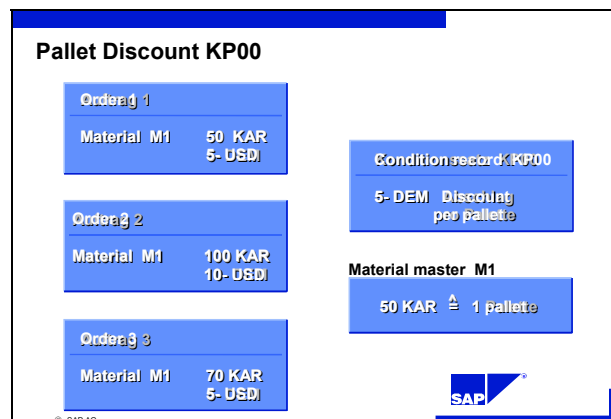

Condition Type KP01

- The aim of the surcharge for an incomplete pallet is to assign a surcharge for

Pallet Discounts

- This is controlled in the pricing procedure using the base value calculation formula 24. This checks the partial quantity.

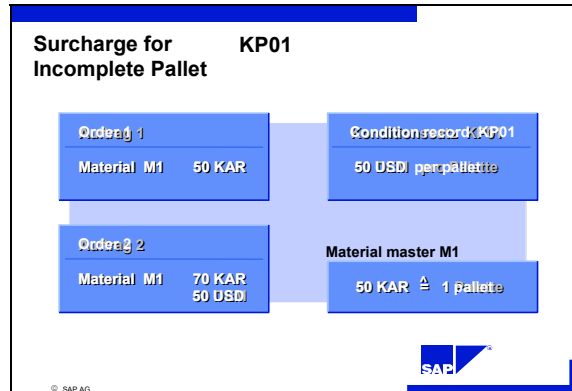

Condition Type KP02

- The aim of the mixed pallet discount is to cumulate the quantities for individual items, but only to calculate the discount for whole pallets.
- This is controlled using the condition type KP02 (Group cond. = X and unit of measure = PAL) and the corresponding condition record.

Pallet Discounts

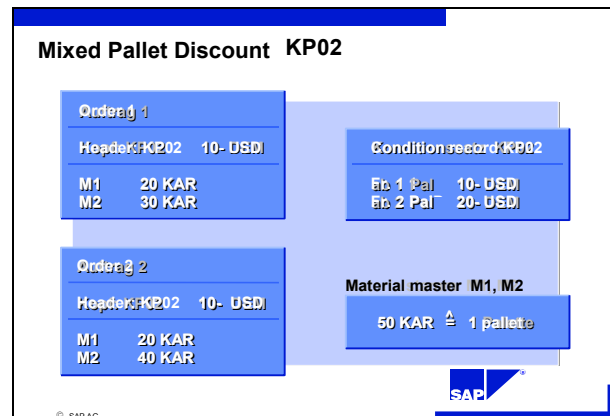

Condition Type KP03

- The aim of the surcharge for an incomplete mixed pallet is to cumulate the quantity of items. If there is a partial pallet quantity for a total quantity, a surcharge should be charged.
- This is controlled using the condition type KP03 (Group cond. = X, unit of measure = PAL and scale formula 23, which calculates the partial pallet quantity from the total quantity).

Surcharge for incomplete mixed pallet KP03

Order 1		Condition set KR03	
Header		from 1	5 DEM
M1	20 KAR		
M2	30 KAR		

Order 2		Material M1, M2	
Header		50 KAR	1 Palette
M1	20 KAR		
M2	40 KAR		

© SAP AG

Hierarchical Accesses

Hierarchical Accesses

Use

Hierarchy accesses are used to optimize pricing for hierarchical data constellations such as a product hierarchy. When using hierarchies of this kind, it may be necessary to use any number of partial quantities (taken from the specified quantity of characteristics) to define the keys of the condition tables. A simple example of this would be a price that is fixed for sales organization and distribution channel but otherwise depends upon either customer, material or both.

Without hierarchy accesses, you would need to create a condition table for every combination and assign all accesses to this table in a hierarchy within an access sequence. This would not only take a great deal of time, but it would also reduce system performance and force the system to use a rigidly fixed sequence of accesses.

This represents a major drawback, especially for hierarchical data such as that representing a product hierarchy or a customer hierarchy.

Using the function, the system can find variants of this kind with a single access to a condition table containing all the necessary fields in the variable key. It can then determine the required condition record according to the relevant criteria.

Prerequisites

When creating an access sequence in a condition table for the fields of an access, the user has the option of defining which part of the key remains fixed and which part can vary (these are the free fields and the optional fields in condition maintenance). During access sequence maintenance, you assign priorities to the fields in the variable part of the key. These priorities are used to evaluate the relevance of the condition records determined using the fixed part of the key.

In Customizing for Pricing, you need to make the following settings in the access at field level:

- Processing type in access (**A**Type field): By entering A, you indicate that it is a free field. Free fields are optional fields during condition record maintenance, so that any combination of characteristics can be created for an access.
- Evaluation of characteristics (**P**rio field): You can assign a priority from 01 (high) to 99 (low).

The records with the highest priorities are then made available in pricing.

The quick entry screen for the condition records is not used. Mandatory entry is not used for the optional fields.



When using hierarchical accesses, you should always use physical deletion and not the deletion indicator. This is because condition records are determined using the priority for hierarchical conditions before Pricing takes place. However the deletion indicator is not checked until Pricing has begun. This can lead to the following:

A condition record may have top priority for the hierarchical accesses and be transferred to Pricing. Using one of the deletion indicators however, the condition record is then sent out of Pricing without a replacement.

You can find more information on deletion in the unit [Deleting condition records \[Page 77\]](#).



Example of Pricing with Free Fields

You want to set up Pricing for materials that are assigned to a product hierarchy. You mark the hierarchy levels as free fields and enter a priority. As a rule, the priority should increase as you move from general to more specific criteria:

Field	Processing type in access	Evaluation
Sales organization		
Material group	A	5
Main group	A	4
Group	A	3
Sub-group	A	2
Material	A	1

The advantage of this is that only one access needs to be created in the access sequence during master data maintenance. This is because the free fields represent optional fields during condition record maintenance, allowing any number of combinations of characteristics for an access.

You also get a much better overview of master data maintenance, because the different condition records can be created for a condition type in the condition maintenance quick entry screen.

Example Data in the Standard System

You can use condition type K148 with access sequence PRHI to test hierarchy accesses.

Data Determination in the Access

Data Determination in the Access

Use

During pricing, you may want to determine data that is not available in the document and then use it for pricing.



Examples:

You may want to grant prices from a wholesale price list to customers in a certain customer group, without changing the master data.

In the document, the price list type is not determined from the master data, it is determined from a special condition record and then made available to pricing.

Or perhaps you want to fix a certain scale quantity for customers in a certain customer group, regardless of the quantity ordered.

The scale quantity must now be determined using a special condition record and then made available for pricing.

This procedure involves two steps:

- Data determination for pricing
- Use of data in pricing

These two steps are different again, depending on how the data is procured, so we must distinguish between three different data determination processes:

- Determination using communication structure KOMPAZD
You can use communication structure KOMPAZD to determine data. This procedure is possible for fields that occur in accesses.
- Data determination using routines
You have to use routines to determine data for fields that are not used in accesses, such as the scale quantity or the pricing date.
- Data Determination for Sales Deals
A special solution is provided for sales deal data determination.

These three procedures will be described in the following units.

Data Determination using a Communication Structure

Data Determination using a Communication Structure

Use

Data determination requires a structure in which the data determined can be stored and accessed from pricing. Communication structure KOMPAZD is provided for this purpose.

The standard system provides the following fields in this structure:

- Price list type
- Exclusion indicator

Communication structure KOMPAZD can be extended in the same way as communication structures KOMKAZ and KOMPAZ.

This is described in SD Customizing under:

Sales and Distribution → *System Modification* → *Create new fields (using condition technique)* → *New fields for pricing*

Prerequisites:

Data determination in the access for pricing takes place at field level. A field is selected for this. It is used for data determination, not pricing. This is carried out as follows:

When maintaining a *condition table*, you can choose a field from the key in the *Technical Settings* field. It is then designated as a data field and is automatically indicated with C in the access in Customizing for access sequences. This is only possible when it is created. If you want to change existing condition tables, you must delete them and then recreate them.



The data used in the following example are provided in the standard system as example data.



Example: Item price list type

You want to grant prices from a wholesale price list to customer within a given period of time, without changing the master data. To do this, the system needs to:

- determine the item price list type, dependent upon the customer
- determine the price using the price list type.

The following conditions must exist in the pricing procedure:

Conditions in the pricing procedure

Condition type	Access sequence
PBP	PBP (for data determination)
PBBS	PR01 (for using the data in pricing)

Data Determination using a Communication Structure

Determining the Price List Type

Access 10 of the access sequence contains the field KOMPAZD PLTYP_D. A field with processing type **C** is used for the data determination:

Access sequence PBP with the following access:

Document structure	Document field	Processing type in access (field AType)
KOMPAZD	PLTYP_D	C (data field for data determination)

Using this access a condition record can be read and determined in relation to the customer e.g. the price list category 04.

Using the Data for Pricing

Pricing condition PBBS has access sequence PR01, which uses the price list type (PLTYP) from field KOMPAZD PLTYP_D (table 6) for pricing. This is price list type 04, that was determined in the previous step.

Access sequence PR01 with the following access:

Document structure	Document field	Processing type in access (field AType)
KOMPAZD	PLTYP_D	

This access reads the following condition records and determines the most favorable price: 190 USD:

Condition records for condition type PR00:

Price list type	Material number	Price
01	4711	200
04	4711	190

Data Determination using Routines

Data Determination using Routines

Use

The previous unit describes data determination for fields within accesses using communication structure KOMPAZD. You can not use communication structure KOMPAZD to determine data for fields that are not used in accesses, such as the scale quantity or the pricing date. In these cases, you must carry out the data transfer using routines.

First of all the data is determined using a condition type such as PBUD, for example. This includes the access sequence PBUD assigned to the condition type PBUD and the pricing date field, which is indicated as a data determination field.

Afterwards a routine can be assigned to the discount, which uses the data for pricing.



Prerequisite: Indicate a field as a data determination field

Data determination in the access for pricing takes place at field level. A field is selected for this. It is used for data determination, not pricing. This is carried out as follows:

When maintaining a *condition table*, you can choose a field from the key in the *Technical Settings* field. It is then designated as a data field and is automatically indicated with C in the access. This is only possible when creating. In exceptional cases you can use it when changing: delete – add new one

In the pricing procedure, condition type PBUD is used for data determination. You can then assign as many discounts/surcharges for use in pricing to the following routines:

Conditions in the pricing procedure:

Condition type	Requirement in the pricing procedure
PBUD (Data determination)	
KXXX (Use of data)	202 (used to apply the pricing date determined using condition type PBUD for pricing)



The data used in the following example are provided in the standard system as example data.



Pricing Date Example

You want to grant prices from a previous year to customers in a certain customer group. These prices are however no longer valid. You enter pricing date 12.31 from the previous year for pricing.

To do this, data must be determined and applied to pricing again. In this example, condition type PBUD is used for determining the data. Pricing then uses this data to determine a suitable discount. In the following example the condition type KXXX is specified. Both conditions must be copied to the pricing procedure.

Data Determination

The access sequence PBUD contains the field KDATU.

The field KDATU is indicated as the data determination field.

Access sequence PBUD with the following access:

Field	Name	Processing type in access (field AType)
KDATU	Pricing date	C (data field for data determination)

This access can be used to read a customer specific condition record, which determines a pricing date as the date from the previous year.

Using the Data for Pricing

You can now assign requirement 202 to a discount in the pricing procedure. This ensures that the pricing date from the previously determined field KDATU is used for pricing.

Data Determination for Sales Deals

Data Determination for Sales Deals

Use

A special data transfer technique is used for sales deal data determination. You enable this by assigning condition class **H** (sales deal determination) in the condition type.



The data used in the following example are provided in the standard system as example data.



Sales Deal Example

You want to determine one or more sales deals for customers within a customer group. You want to use these sales deals to determine material prices.

The following condition types must exist in the pricing procedure:

Conditions in the pricing procedure:

Condition type	Condition class	Access sequence	Requirement
PB1 (used for data determination)	H	PBD	
PB1D (used for data application)	A	PBUD	062 (used for completing internal tables for several determined sales deals)

(The standard system provides sales deal type PRB1, to which these condition types are assigned).

Data Determination

Condition type PB1 and access PBD are used to determine one or more sales deals.



You may want to determine several sales deals, since more than one may be relevant for the customer. In this case, you can not use the data determination methods using processing type C, as described above, because a condition with the same key can only occur once. Here, you can use data determination **B**, which marks a key field for data determination. This allows for several records with identical customer data but different sales deal numbers.

You specify data determination **B** for a field in the access of an access sequence.

Access Sequence for Data Determination:

Access sequence PBD with the following access:

Data Determination for Sales Deals

Field	Field description	Processing type in access (field <i>PType</i>)
KNUMA_AG	Sales deal	B (key field for data determination)

This access reads the following condition record and determines sales deal numbers 01 and 02:

Condition record

For condition type PB1:

Sold-to party	Sales deal	
0001	01	
0001	02	

Data application:

Condition type PB1D has access sequence PBUD, which contains the sales deal in its key:

Access sequence PBUD with the following access:

Document structure	Document field	Processing type in access (field <i>AType</i>)
KOMP	KNUMA_AG	

The following condition records are read using this access. Different discounts can now be granted, depending on where the sales deals apply.

Condition record for condition type PB1D:

Sales deal	Material group	Discount
01	01	- 2,00 %
02	01	- 3,00 %

Price Book

Price Book

Use

The term 'Price Book' is used to describe a pricing determination strategy:

Material prices form the basis of the price book.

These prices are first determined via customer-specific data and then adapted according to special agreements determined via material-specific data.

Pricing procedure RVAA02 is provided in the standard system as an example.

This pricing procedure is described below. Make sure that you are familiar with the different types of data determination, as described in the previous units, before reading this example.

Example of a Price Book (Pricing Procedure RVAA02)

You want to grant special prices to customers in a certain customer group. You want special, material-dependent agreements (e.g. fixed scale quantities) to be applied to these prices during pricing, however.

You arrange this via data determination in two stages:

- Level 1: You determine the sales deal number with reference to the customer group.
- Level 2: You determine the special agreements, dependent upon the material group and with reference to the pricing date, the scale quantity and the item price list.

Data determination in two stages:

Condition type	Name	Function	Data determination technique
PBU	Price book determination	Determination of a sales deal number (depends on customer data)	Data determination with condition class H for sales deals (see the unit on data determination for sales deals)
PBUD	Price book basis	Determination of the following data (material-dependent) for the sales deal number determined. Pricing date Scale quantity Item price list	The sales deal is in the access key The data determined have processing type C (data determination fields) in the access (see the unit on data determination with routines).

The special agreements determined are used in pricing for the following condition.

Data application:

Condition type	Name	Function	Data transfer
PBBS	Base price	Use of the data determined: Pricing date Scale quantity Item price list	Requirement 202 in the pricing procedure Scale basis formula 202 in the condition type (see the unit on data determination with routines) Communication structure KOMPAZD (see the unit on data determination with a communication structure)
PBUP	Gross price	You can use condition PBUP to make a percentage calculation for the preceding condition	Basis formula 202 in the pricing procedure

Condition Interchange

Condition Interchange

Use

You want to interchange conditions with other SAP systems or with external systems.

Examples of Inbound Processes:

- Provides R/3 with data from the old or external system, for example, in the introductory phase
- Transfers the stipulated retail prices from a vendor
- Transfers the individual retail prices from a wholesale customer

Examples of Outbound Processes:

- Provides price information for new materials from the subsystems
- Provides a new subsystem with price information

What are the New Developments in Outbound Processing?

- Automatic selection and distribution using change documents from price and condition maintenance
- Manual selection and distribution without the need for change documents (for condition maintenance this can be done in *Condition Info*)
- Idoc modification option via Customer Functions

What are the New Developments in Outbound Processing?

- You can transfer Idocs into the master conditions (tables: Axxx, Konh, Konp, Konm/Konw)
- this also applies to purchasing info records
- document-related conditions (contracts)
- and purchasing rebates (agreement)
- but not for other agreements (KONA reference)
- and not for free goods
- You have the option of modifying Idocs via Customer Functions

Idocs and Condition Technology

Overview of Condition Technology

- **Overview**

- In example of use application

A = Pricing
V = Sales and distribution

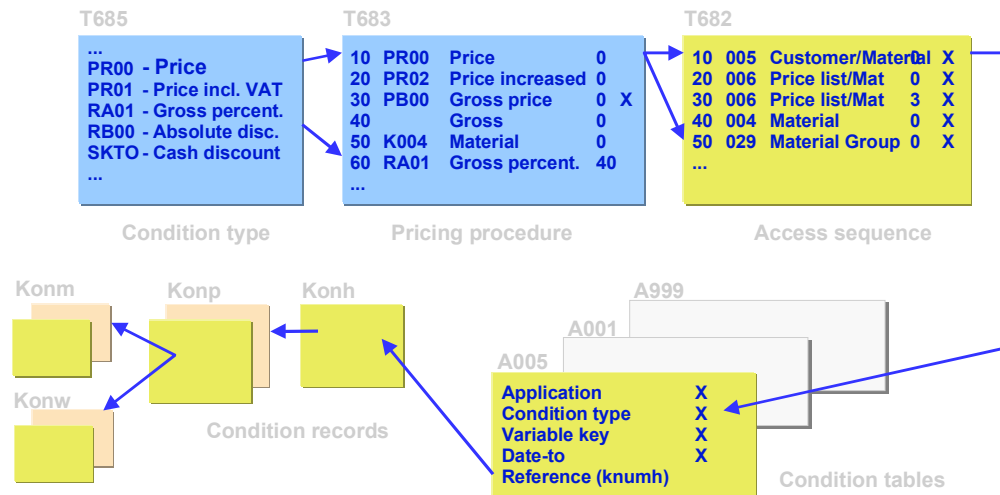

- The condition type shows what type of condition it is; price, surcharge or discount in value or percentage or values
- The pricing procedure specifies the sequence in which the condition types are used for determining prices and the rules used to determine prices
- The access sequence is defined in the condition type and determines the sequence in which the system searches for valid entries in the condition tables. You can carry out a special search (here, customer and material) or a more general search (material group)
- The condition table represents the validity periods for the individual condition records You can link to the condition records using a single condition record number (knumh)
- Condition records:
 - Konh: Condition header
 - Konp: Condition item(s) possibly with supplementary conditions
 - Konm/Konw : Quantity scale or value scale

Structure of an Idoc:

E1KOMG	for filter functions	(1:obligatory)
E1KONH	Condition header	(n:obligatory)
E1KONP	Condition item	(m:obligatory)
E1KONM	Quantity scale	(i:optional)

Idocs and Condition Technology

E1KONW Value scale (j:optional)

E1KONH

E1KONP Condition item (m:obligatory)

and so on.

All condition records are combined in an Idoc which fulfils specific criteria (See Serialization)

Application + Condition type + Condition table + VAKEY

The Konh blocks are the individual validity periods in a logical unit (see Serialization)

Terms

- **Idoc type:** COND_A01 determines the hierarchical structure of an Idoc for price/condition interchange
- **Idocs** and their segments are assigned to the Idoc type
- **Output category:** COND_A is assigned to the IDOC type. Reduced output categories from the customer are possible
- **Reduction option:** individual fields from the Idoc segments can be reduced. This means that they can be transferred without data. Reduced output categories from the customer can be created, that reference the Idoc type Cond_A01. The reduction option is planned at segment and field level. Whole Idoc segments can be excluded from the transfer (see Customer Adaptation)

Outbound Processing

Manual Selection and Distribution

- For each condition type using the condition records display (condition info) with the following selection options:

Valid-from or validity area

Check box with individual, block or total selection options.

You can display the condition table

You can select the (reduction) output category and, if required, the target system

- Transferring the selected data to the send module 'MASTERIDOC_CREATE_COND_A'
- In the ALE layer: Select recipient, filter, convert,...



- In condition maintenance you can call up the condition info for a condition type which allows you to show all of the condition records available in a system on a selection screen. You can select and send condition records in this display
- Condition records with several validity periods are marked in color
- When sending the marked condition a popup appears, in which you can enter:
any deviating output categories (reduced output)
a logical system; if the field remains empty, the output is sent to all systems defined in the partner agreement.

Automatic Selection and Distribution

- Processing of change documents **COND_A** from condition and price maintenance with the function module **MASTERIDOC_CREATE_SMD_COND_A**
- Call up is done using the report **RBDMIDOC** with the output category **COND_A** as a parameter
- Check via the partner agreement to see whether a system is interested in the data
- Structure of Idocs and sending with function module
- In the ALE layer: Select recipient, filter, convert,...

Special Features of Outbound Processing

Filter and Distribution Function

- VAKEY in E1KOMG segment
E2KOMG contains (almost) all fields that can be used as key fields from condition tables.
E1KOMG extends to important fields from the condition header (Usage, application, table number, condition type, retail promotion number,...)

Outbound Processing

E1KOMG extends to fields for conditions with reference (for example, for contracts, info records) = (Purchasing document category, type, purchasing group,...)

- Call Customer Function for data enhancement
- Customer-specific segment at E1KOMG level possible for further filtering and distribution functions
- EKKO fields: if Komg-evrtn is completed
- EKKO fields: if Komg-kont_pack is completed (service header) from 4.0C

Significance of VAKEY in the E1KOMG segment

The key fields in a condition table often contain the actual recipient data for dispatching conditions. These fields are defined in code in VAKEY in the condition header. The E1KOMG segment contains this data uncoded; it can therefore be used for filter and distribution functions by using standard ALE functions. As the E1KOMG must be firmly defined and cannot be extended to customer-specific key fields (XKONG), these fields must be transferred into the target system via VAKEY. For this reason the VAKEY is also included in the segment. In

Outbound processing:

- The Vakey from the condition record is evaluated and transferred into the corresponding fields in the KOMG structure (there may be customer key fields available)
- Customer function for modifying the KOMG structure that is already constructed. These can be enhanced for the filter and distribution functions, which means that data in available fields can be included again. Existing data contents can be assigned a new key
- The fields of a modified KOMG structure are transferred into the E1KOMG structure, if this is available in the structure

The vakey is restructured from the modified KOMG structure and is transferred into the VAKEY and VAKEY_LONG (Rel4.0) fields in the E1KOMG structure.

In **inbound** processing:

- The vakey from the transferred E1KOMG structure is evaluated and is transferred into the corresponding fields of the KOMG structure for condition installation
- Customer function for modifying the KOMG structure that is already constructed for assigning a new key to existing data or enhancing existing data which is also used in the condition table for the target system.
- The condition is created with the content of the KOMG structure

This procedure means that the field new key assignments offered from the ALE layer can not be used for conversion rules in inbound and outbound processing for the E1KOMG segment, since the content of the vakey must also be converted with it. This cannot be done however with the current methods available in the conversion rules (COMBINE or GROUP). These new key assignments must be carried out via customer functions in inbound or outbound processing as described above, whereby the vakey must be adapted accordingly.

Error handling

- Everything available with the standard transaction 'BALE'
documents created with their processing statistics
Idoc segments with the data to be sent

Outbound Processing

- manual sending: sends you a message to say whether successful or unsuccessful
- automatic sending:
only formally consistent conditions are transferred; the change pointer is set to 'processed'
the status of the change pointer is not changed if the errors were from the system

Validity periods

- manual sending
the individually selected conditions are sent with their validity area
- automatic sending:
all validity periods where the to_date is > than today's date are determined for each condition record number. These validity periods are sent (consistency between source and target system).

Inbound Processing

Inbound Processing

What can be Processed?

- Prices and conditions (master conditions)
 - Axxx Condition table
 - Client + Application + Condition type + VAKEY + Valid_to
 - Konh Condition header
 - Client + Condition record number (knumh)
 - Konp Condition item
 - Client + Knumh + current number
- Condition supplements (Purchasing and Sales and Distribution)
 - Konp Condition item
- Scales
 - Konm Quantity scale
 - Client + knumh + current number + current no. scale
 - Konw Value scale
 - Client + knumh + current number + current no. scale

for purchasing info records
- Document-related conditions
 - for contracts
 - for purchasing rebate agreements (and the period condition records)
 - no other agreements

Processing module

- The inbound processing module IDOC_INPUT_COND_A is assigned to the Idoc type COND_A01.
- The Idoc data is read, checked, formatted and transferred to the SD standard function module RV_CONDITION_COPY.
- Transfer to dialog module RV_CONDITION_MAINTENANCE
- Preparation of the data; for example, adapting time periods and posting condition records with RV_CONDITION_SAVE to the database



- IDoc_Input_Cond_A carries out the same checks that the condition installation carries out per dialog before transferring further to Rv_Condition_Copy. This means that only syntactically correct condition records make it into posting.

Inbound Processing

- Incorrect records remain in Idoc inbound processing and list all of the errors that have occurred in their logs.
- In the target system new conditions records are always created, this means that a new condition record number is always assigned.
- If there are time gaps due to condition changes remaining in the source system, these do not always exist in the target system.
- Time links via the condition record number get lost
- The maintenance of conditions can not be split up, for example, prices in the source system and scales in the target system.
- When sending with change documents all validity periods concerned >= today's date are sent for each condition record number (Consistency)



Gaps in the target system:

Source system: 1.) AAAAABBBBBCCCC

2.) AAAAA BBBCCCC abbreviation of BBBB

3.) sent from BBB

4.) AAAAA BBBCCCC current status of the DB

Target system: 1.) DDDDDKKKKKEEEEE identical to source

2.) Initial data creation of BBB

3.) DDDDDKBBBEEEEEE a part of KKKKK remains

New condition record number:

Source system 1.)AAAAABBBBBAAAAA AAAAA has the same Knumh

2.) complete dispatch

Target system 1.) DDDDDKKKKKEEEEE each with different Knumh

Distribution Scenarios

Distribution Scenarios

Purchasing Information Record / Contract

When maintaining info records and contracts it is assumed that change documents will be created for the actual data as well as for the relevant conditions.

Data dispatch is then carried out separately.

During inbound processing of conditions, checks are made to see whether the info record or the contract is already available in the target system with the same number as in the source system.

Rebate Agreement in Purchasing (Agreement)

The applicable conditions can be dispatched manually once. The change documents belonging to them are not processed.

Other Agreements (KONA reference)

Conditions for these cannot be dispatched.

Free Goods Conditions

Cannot be dispatched.

SP with Material (Retail)



- Price transfer as a pure document condition and not as a master condition takes place using the branch and customer order Idocs (from 4.0A)
- Conditions for agreements create problems, because the statistics for the corresponding agreements are related to the condition record numbers. When posting condition changes to an agreement, a new condition record number is assigned in the target system and the statistics previously available can no longer be used.
- If you find that this is not yet available (condition distribution has taken over contract distribution) in the target system (with the same number as in the source system) during processing of conditions for agreements or contracts, the condition Idocs are not processed. They remain in inbound processing and can be redirected back to posting later if the contracts/info records are available.

Customizing

- Customizing data for condition technology is not transferred
- Customizing in the source and target systems must be the same
- Certain conversions are however possible, for example:
 - Rename the condition type
 - Rename the condition table
- The following are not possible:
 - Conversion of a percentage condition type into an amount condition type
 - Converting value scale into a quantity scale
- The master data in the source and target system must be the same and must be available
- For organizational purposes you must make sure that the number range settings in the target system do not mean that you end up with two identical keys
- ISO scale:
 - Countries, units of measure, currencies and other amounts are transferred according to the ISO standard. If there is no ISO code for SAP_Code, the SAP_Code is transferred (outbound)
 - If the ISO-SAP conversion in inbound processing is not completely clear, an error message is issued

Customer Exits

Customer Exits

Outbound

- Customer function '001'
Derives KOMG data for distribution and filter functions
- Customer function '002'
Completes a customer segment. It can be used for other filter and distribution function purposes.

Inbound

- Customer function '001'
Changes the segment E1KOMG (for example, condition type or table)
- Customer function '002'
Posts the customer segment



If the customer-specific segment for filter and distribution functions is to be used, it must be defined on the same hierarchy level as the E1KOMG segment as an obligatory segment.

Miscellaneous

- Reducing segments
The segments for the value or quantity scales can be excluded from the transfer (E1KONM, E1KONW). No scales are created in the target system. After initial data creation, any scales that were available are no longer valid.
- Reducing to field level
Field contents can be assigned with the 'Reduce character' (for example, = /). In contrast to other master data transfers, the values for the corresponding fields do not remain in the target system but are initialized.

Serialization

Idoc = Logical Unit

The logical unit for conditions consists of:

- Application + Condition type + Condition table + VAKEY
- All data that should be transferred and which belongs to one logical unit, is combined into one Idoc and is dispatched. (that is to say specially for all time periods)
- This unit is also the basis for serialization in inbound processing. In inbound processing only earlier data can be processed for a logical unit.



If two new validity areas are created in the source system and are imported into the target system in the wrong sequence, you may get a different result to the one in the source system. This is not a problem as all possible validity periods for a condition record number are transferred and only earlier data is processed for a logical unit.



Example: The following data should be transferred:

Appl	CoArt	CoTab	VaKey	knumh	Value	Valid
M		PB00	A016 R001R01 01	000005	3,50	01.06.-30.06
M		PB00	A016 R001R01 01	000126	3,40	01.07.-20.08
M		PB00	A016 R001R01 01	000005	3,50	21.08.-31.12
M		PB00	A016 R001R02 01	000055	3,50	01.07.-31.12

2 Idocs are created:

```

KOMG          with M+PB00+A016+R001R01 01 .....
  KONH        with knumh=000005 + 01.06.-30.06. ....
    KONP      with data... 3,50 .....
  KONH        with knumh=000126 + 01.07.-20,08. ....
    KONP      with data... 3,40 .....
  KONH        with knumh=000005 +21.08.-31.12. ....
    KONP      with data... 3,50 .....
    
```

```

-----
KOMG          with M+PB00+A016+R001R02 01 .....
  KONH        with knumh=000055 + 01.07.-31.12. ....
    KONP      with data... 3,50 .....
    
```

Pricing Information and Analysis

Use

There are several ways to get information about pricing and condition records. For example, during sales order processing, you can carry out a [pricing analysis \[Page 145\]](#) from the pricing screen. The analysis provides detailed information about which condition types were used, and which condition types were or were not found. In addition, you can display information about pricing master data (condition records). For example, you can search for all condition records regardless of condition type where a particular material is used as part of the condition record key ([searching for condition records via an index \[Page 78\]](#)).

Pricing Analysis

Use

When you are working in a sales or billing document, you can branch from the item pricing screen to a pricing analysis. You receive a list of all conditions for an item and a short overview of the transaction in automatic pricing. This information allows you to check how the system calculated the various pricing elements for an item.

Information in the Pricing Analysis

The analysis screen is divided into three.

In the **left-hand side** of the screen, an overview tree shows the four levels of pricing. These are:

- the pricing procedure
- condition types
- accesses
- any condition records found

In the **upper right-hand side** of the screen you receive more detailed information for the level of the overview tree that you have selected.

- At condition type level you receive information on the number of accesses and why accesses have not been implemented. If a requirement for a condition type in the pricing procedure has not been met, you have the option to display routines by selecting *Information*.
- At the access level you receive information on which fields work with an access. By selecting the *technical view* you can see the field names for an access.
- At condition record level you can branch into the relevant condition record.

In the **lower right-hand side of the screen** you receive additional documentation for the access and condition levels. You can use this if the information in the detail screen is not enough.

Pricing Reports

Pricing Reports

Use

If you want information about pricing data stored in the system, you can create pricing reports. Pricing reports put together information from condition records, condition types and condition tables according to various different criteria. A report can provide you, for example, with answers to the following questions:

- Which customer-specific price agreements were made within a certain period?
- Which condition records exist for freight charges?
- Which condition records exist for customers in a particular region or country?

Creating Pricing Reports

Pricing reports are created in Customizing according to your company requirements and can be executed via the application menu. By using specific selection criteria you can change the scope of the pricing report, but you cannot change the criteria used to create the pricing report. This is carried out in Customizing.

Additional Ways of Evaluating Condition Records

In addition to using pricing reports to generate information about condition records, you can also carry out evaluations of specific condition types while you are working with condition records. In the overview screen of a condition record, choose *Environment* → *Condition information*. You then reach a selection screen, where you can evaluate condition records according to specific criteria.



Pricing reports can also be used for maintaining conditions. Read [Maintaining Condition Records \[Page 43\]](#).

Creating Pricing Reports

Use

You can create your own pricing reports in Customizing for Sales and Distribution under *Sales and Distribution* → *Basic Functions* → *Pricing* (Transaction V/LA). Technically speaking, pricing reports represent ABAP/4 programs.



The SAP Standard System contains pre-defined pricing reports, that can be started via the application menu (Choose *Logistics* → *Sales and Distribution* → *Master Data* → *Information system* → *Conditions and Pricing* → *Pricing Reports*). Pricing reports can also be used for maintaining conditions. Read [Maintaining Condition Records \[Page 43\]](#).

Procedure

Check the extent to which the pricing reports in the SAP Standard System can be used. You can also display the defined pricing reports.

Create new pricing reports (in Customizing under *Sales and Distribution* → *Basic Functions* → *Pricing*, transaction V/LA). Proceed as follows:

- Enter a short text name, consisting of two characters, the first of which must be a letter, and the title of a pricing report that you would like to create. On the next data screen you will see all key fields used in conditions, listed in alphabetical order. Select all key fields that should be taken into consideration in the pricing report.
- If you choose “Edit -> continue with AND”, all condition tables are evaluated, that contain at least one of the selected key fields. If you choose “Edit -> continue with AND”, all condition tables are evaluated, that contain at least one of the selected key fields. In the next dialog box, mark all condition tables that are to be evaluated.
- Choose “Continue to list structure” to define the screen structure for the pricing report. Make sure that on the next screen all key fields from the selected tables appear. Fields, that are not used as selection criteria when displaying the list later, can be removed by undoing selection in the “Selection” column. Fields can be marked as obligatory fields on the selection screen. The structure of the pricing reports means that information can be placed in different places in the list. The layout contains the following elements:

-

This layout element...	has the following function in the list...
Page header	Information that applies to each report page
Group header	Subdivides information into categories
Item	Specific information from a condition record

Example

The following figure illustrates a section from a sample pricing report that provides information about customer-specific prices but does not include details of pricing scales. The different layout elements are indicated in the figure.

Creating Pricing Reports

Customer-specific prices without scale display						
	List	Edit	Goto	System	Help	
Page header →	Sales organization		0001	North Germany		
	Distribution channel01	Rep. visit		
Group header →	Customer					
Items →	Cond. type	Material	Amount	Unit	per	UM valid from
	...					
	Cust A					
	PR00	Mat1	10	USD	1	ST 10.01.1993
		K005	20	USD	1	KG 15.01.1993
		PR00	15	USD	1	ST 15.01.1993
	Cust B					
	PR00	Mat1	9	USD	1	ST 10.01.1993
	
	

Running a Pricing Report

Steps:

To run a pricing report:

1. In the initial screen choose *Logistics* → *Sales and Distribution* → *Master data* → *Information system* → *Conditions and pricing* → *Pricing Reports (Transaction V/LD)*.

You reach the *Execute Pricing Report* screen.

2. Enter the name of the pricing report you want to run.

If you do not know the name, choose *Possible entries*. A dialog box appears, in which you can search for a report either by the report name or by the descriptive title or by both. You can also search generically by entering *. If you choose *Continue*, the system lists all the available pricing reports.

If you leave both fields blank and choose *Continue*, the system displays all available pricing reports.

3. Choose *Execute*.

You reach the selection screen for the pricing report you want to run.

The screen sections in the selection screen detail how the list is structured. The fields in the areas *Page header*, *Group header* and *Items* specify where the fields are placed in the pricing report. An arrow in the lower right section of the screen means that there are more fields in the pricing report than displayed on the current data screen.

4. Limit the report by specifying selection criteria so that you obtain the relevant information.
5. You can use *Free accruals* to enter additional selection criteria, that is not displayed on the selection screen. You can, for example, assign the order taker to a condition as a selection criteria.
6. Choose *Execute*.

The system displays the pricing report.

The more information the list contains, the more complex the handling of the list. You can display wide lists using the horizontal screen strip? You can also work with a larger window.

Printing the Pricing Report

To print out a pricing report, choose *Print*. on the Pricing Report screen. On the following screen, enter the output device and the specifications on spool control and choose *Output* → *Print*.

Working with Variants of Pricing Reports

If you frequently use pricing reports with the same selection criteria, you can store the pricing reports as variants and use them again later. When you run the pricing report, you can then call up the variant and the system automatically enters the selection criteria for you. To create and maintain variants from the selection screen of a pricing report, choose *Goto* → *Variants*.

Running a Pricing Report

Net Price Lists

Use

The net price list allows you to provide your customers with pricing information on materials.

Features

In the menu, choose: *Sales and distribution* → *Master data* → *Pricing reports* → *Net price lists*.

Enter the sales area, the sold-to party and the plant.

Enter the data that influences pricing (such as order type and pricing date).

After starting program SDNETPRO a billing document is simulated and the system issues the result.



The net price list works with the ABAP List Viewer.

You can define your own display variants using the ABAP List Viewer. All fields of table VBRP are also available. Subtotal fields KZW11 to KZW16 can be used to create customer-specific information.

You can find more information on the ABAP List Viewer in: *Cross Application Components* → *General Application Functions*